C1000™ Thermal Cycler

Instruction Manual

Catalog Numbers

184-1000

185-1048

185-1096

185-1384

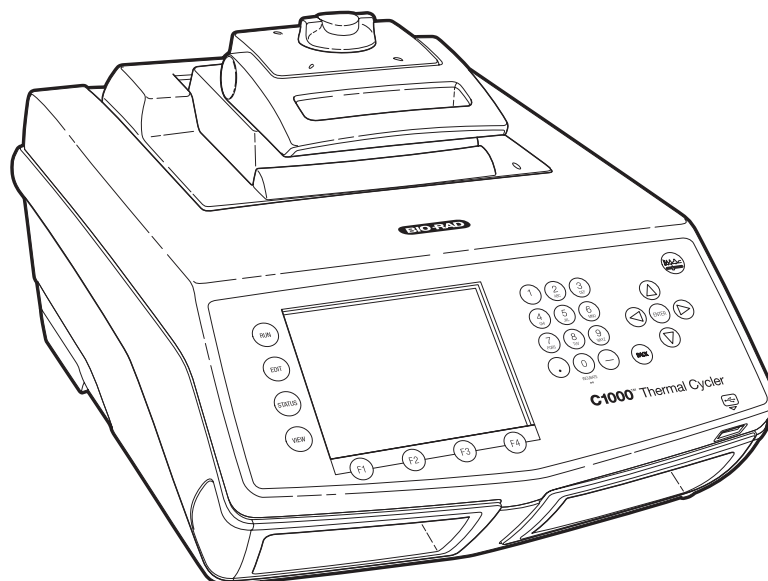

Copyright ©2008 Bio-Rad Laboratories, Inc. Reproduction in any form, either print or electronic, is prohibited without written permission of Bio-Rad Laboratories, Inc.

Chill-out, iProof and iTaq are trademarks belonging to Bio-Rad Laboratories, Inc.

DNA Engine, and iCycler are registered trademarks belonging to Bio-Rad Laboratories, Inc.

Other brands or product names are trademarks of their respective holders.

LICENSE NOTICE TO PURCHASER

This base unit, Serial No. _____, in combination with its immediately attached Bio-Rad sample block module(s), constitutes a thermal cycler whose purchase conveys a limited non-transferable immunity from suit for the purchaser's own internal research and development and for use in applied fields other than Human In Vitro Diagnostics under one or more of U.S. Patents Nos. 5,656,493, 5,333,675, 5,475,610 (claims 1, 44, 158, 160-163 and 167 only), and 6,703,236 (claims 1-7 only), or corresponding claims in their non-U.S. counterparts, owned by Applera Corporation. No right is conveyed expressly, by implication or by estoppel under any other patent claim, such as claims to apparatus, reagents, kits, or methods such as 5' nuclease methods. Further information on purchasing licenses may be obtained by contacting the Director of Licensing, Applied Biosystems, 850 Lincoln Centre Drive, Foster City, California 94404, USA.

This C1000 thermal cycler, when combined with a CFX96™ detection module bearing a valid label license under U.S. Patent No. 6,814,934, constitutes a real time thermal cycler licensed under U.S. Patent No. 6,814,934 and corresponding claims in any Canadian counterpart patent thereof owned by Applera Corporation, for use solely in research and all applied fields except human and veterinary in vitro diagnostics, provided that the real time thermal cycler royalty fee that is applicable to said thermal cycler has been paid. No rights are conveyed expressly, by implication or estoppel to any patents on real time methods, including but not limited to 5' nuclease assays, or to any patent claiming a reagent or kit. For further information on purchasing license rights, contact the Director of Licensing at Applied Biosystems, 850 Lincoln Centre Drive, Foster City, California, 94404, USA.

This product is covered by one or more of the following U.S. patents, their foreign counterparts, or their foreign patents pending, owned by Eppendorf AG: US Patent Nos. 6,767, 512 and 7,074,367. No rights are conveyed expressly, by implication or estoppel to any patents on PCR methods, or to any patent claiming a reagent or kit.

Bio-Rad Laboratories Resources

Bio-Rad Laboratories provides many resources for scientists. The following web sites contain useful information for running PCR and real-time PCR experiments:

- **Gene Expression Gateway (www.bio-rad.com/genomics/)**
This site provides many technical resources on a wide variety of methods and applications related to PCR, real-time PCR, and gene expression.
- **Life Science Research web site (discover.bio-rad.com)**
This site includes links to technical notes, manuals, product information, and technical support.

Table 1 lists Bio-Rad Laboratories resources and how to locate what you need.

Table 1. Bio-Rad resources

Resource	How to Contact
Local Bio-Rad Laboratories representatives	Find local information and contacts on the Bio-Rad Laboratories web site by selecting your country on the home page (www.bio-rad.com). Find the nearest international office listed on the back of this manual
Technical notes and literature	Go to the Bio-Rad Laboratories web site (www.bio-rad.com) or Gene Expression Gateway (www.bio-rad.com/genomics/). Type a term in the Search box and select Literature to find links to technical notes, manuals, and other literature
Technical specialists	To find local technical support on the phone, contact your nearest Bio-Rad Laboratories office. For technical support in the United States and Canada, call 1-800-424-6723 (toll-free phone), and select the technical support option

Warranty

The C1000 thermal cycler and associated accessories are covered by a standard Bio-Rad Laboratories warranty. Contact your local Bio-Rad Laboratories office for the details of the warranty.

Writing Conventions Used in This Manual

This manual provides instructions on how to safely set up and operate the C1000 thermal cycler and uses the writing conventions shown in Table 2 to quickly provide relevant information.

Table 2. Manual convention

Convention	Meaning
TIP:	Provides helpful instructions, including information explained in further detail elsewhere in this manual
NOTE:	Provides important information, including information explained in further detail elsewhere in this manual
WARNING!	Explains crucial information about a topic that may lead to injury to the user, instrument damage, or data loss

Table 2. Manual convention (continued)

Convention	Meaning
Screen message	Indicates the one or more words on the screen the user should select
NAME of control panel key	Indicates a key on the thermal cycler control panel.
Select X	Select X using the arrow keys or mouse. For example, select NEW means use the arrow keys or a mouse to select the NEW option on the screen
Select X > Y	From menu X , select Y . For example, select MAIN > RUN means select the RUN option in the MAIN menu
Press X	Press the X key on the control panel. For example, press ENTER means press the ENTER key on the control panel



Safety and Regulatory Compliance

The C1000 thermal cycler heats and cools very quickly during operation. We strongly recommend that you follow the safety specifications listed in this section and throughout this manual.

Safety Warning Labels

Warning labels posted on the instrument and in this manual warn you about sources of injury or harm. Refer to Table 3 to review the meaning of each safety warning label.





Table 3. Instrument safety warning labels

Icon	Meaning
	CAUTION: Risk of danger! This symbol identifies components that pose a risk of personal injury or damage to the instrument if improperly handled. Wherever this symbol appears, consult the manual for further information before proceeding
	CAUTION: Risk of electrical shock! This symbol identifies components that pose a risk of electrical shock if improperly handled
	CAUTION: Hot surface! This symbol identifies components that pose a risk of personal injury due to excessive heat if improperly handled

Instrument Safety Warnings

The following warning labels display on the instrument, and refer directly to the safe use of this C1000 thermal cycler (Table 4).

Table 4. Instrument safety warning labels

Icon	Meaning
	Warning about risk of harm to body or equipment. Operating the C1000 instrument before reading this manual can constitute a personal injury hazard. Only qualified laboratory personnel should operate this instrument
	Warning about risk of harm to body or equipment from electrical shock. Do not attempt to repair or remove the outer case of this thermal cycler base, power supply, heat pump, or other accessories. If you open these instruments, you put yourself at risk for electrical shock and void your warranty. All repairs must be done by an authorized repair service
	Never remove the outer case of a thermal cycler base. This may cause you to receive an electrical shock. This thermal cycler uses neutral fusing, which means that live power could still be exposed inside the instrument even when the fuse is blown or removed
	Warning about risk of burning. A thermal cycler generates enough heat to cause serious burns. Wear safety goggles or other eye protection at all times during operation. Always allow the sample block to return to idle temperature before opening the lid and removing samples. Always allow maximum clearance to avoid accidental skin burns
	Warning about risk of explosion. The sample blocks can become hot enough during the course of normal operation to cause liquids to boil and explode

Safety and Regulatory Compliance

This instrument has been tested and found to be in compliance with all applicable requirements of the following safety and electromagnetic standards (Table 5).

Table 5. Safe use specifications

Safe User Requirements		Specifications
Input power	Rated	100–240 Vac, 50–60 Hz, 400 W Max
Fuses		2 6.3 A, 250 V, 5 x 20 mm
Temperature	Indoor use	Ambient temperature of 15–31°C. Relative humidity maximum of 80% (noncondensing)
Altitude		Up to 2,000 meters above sea level
Overvoltage Categories		II
Pollution degree		2

SAFETY COMPLIANCE

This instrument has been tested and found to be in compliance with all applicable requirements of the following safety and electromagnetic standards:

- UL Std No. 61010A-1 Electrical Equipment for Measurement, Control, and Laboratory Use, Part 1: General Requirements
- UL Std No. 61010A-2-010 Electrical Equipment for Measurement, Control, and Laboratory Use, Part 1: General Requirements
- CAN/CSA C22.2 No. 1010.1-92 - Safety Requirements for Electrical Equipment for Measurement, Control, and Laboratory Use, Part 1: General Requirements (includes Amendment 1)
- CAN/CSA C22.2 No. 1010.1B-97 - Amendment 2 CAN/CSA C22.2 No. 1010.1-92 - Safety Requirements for Electrical Equipment for Measurement, Control, and Laboratory Use, Part 1: General Requirements
- CAN/CSA C22.2 No. 1010.2.010A-97 - Safety Requirements for Electrical Equipment for Measurement, Control, and Laboratory Use, Part 2-010: Particular Requirements for Laboratory Equipment for the Heating of Materials, Amendment No. 1
- IEC 61010-1 Safety Requirements for Electrical Equipment for Measurement, Control, and Laboratory Use, Part 1: General Requirements
- IEC 61010-1 Safety Requirements for Electrical Equipment for Measurement, Control, and Laboratory use, Part 2: Particular Requirements for Laboratory Equipment for the Heating of Materials

ELECTROMAGNETIC COMPATIBILITY (EMC)

- FCC Title 47 Part 15B as a Class A digital device.
- EN61326 Class A Electrical Equipment for measurement, control, and laboratory use - EMC Requirements

FCC WARNINGS AND NOTES

- **Warning.** Changes or modifications to this unit, not expressly approved by the party responsible for compliance, could void the user's authority to operate the equipment.
- **Note.** This equipment has been tested and found to comply with the limits for a Class A digital device, pursuant to part 15 of the FCC Rules. These limits are designed to provide reasonable protection against harmful interference when the equipment is operated in a commercial environment. This equipment generates, uses, and can radiate radio frequency energy and, if not installed and used in accordance with the instruction manual, may cause harmful interference to radio communications. Operation of this equipment in a residential area is likely to cause harmful interference in which case the user will be required to correct the interference, at his own expense.
- **Note regarding FCC compliance.** Although this design of instrument has been tested and found to comply with Part 15, Subpart B of the FCC Rules for a Class A digital device, please note that this compliance is voluntary, for the instrument qualifies as an "exempted device" under 47 CFR 15.103(c), in regard to the cited FCC regulations in effect at the time of manufacture.
- **Note regarding Canadian EMC compliance:** Le present appareil numerique n'emet pas de bruits radioelectrique depassant les limites applicables aux appareils numeriques de class A prescrites dans le reglement sur le brouillage radioelectrique edicte par le Ministere des Communications du Canada.
- **Cables.** Shielded cables must be used with this unit to ensure compliance with the Class A FCC limits.
- **Use only Bio-Rad USB cable (catalog #184-8000) when using any 1000-series cyclers.**

Table of Contents

Bio-Rad Laboratories Resources	iii
Warranty	iii
Writing Conventions Used in This Manual.....	iii
Safety and Regulatory Compliance.....	iv
Chapter 1. Introduction to the C1000 Thermal Cycler	1
System Overview	1
Reaction Modules	4
Setting up the C1000 Thermal Cycler	5
Operating the Reaction Module Lid.....	7
Renaming the C1000 Thermal Cycler	12
Setting Up Email Notification.....	14
Chapter 2. Creating, Editing, Naming, and Saving Protocols	19
Creating a New Protocol or Editing an Existing Protocol	19
Sample Volume and Lid Temperature.....	31
Naming a Protocol.....	33
Saving a Protocol.....	33
Chapter 3. Running Protocols	35
Preparing to Run a Protocol	35
Monitoring a Run	38
Pausing and Resuming a Run	39
Skipping Steps in a Protocol	40
Canceling a Run.....	41
Incubating Samples.....	43
Chapter 4. Protocol AutoWriter	45
Overview of the Protocol AutoWriter.....	45
The Ta Calculator.....	46
Creating a Protocol with the Protocol AutoWriter	48

Chapter 5. Managing Protocol Files and Folders	53
Contents of a Protocol File	53
Managing Protocol Files and Folders	54
Chapter 6. Optimizing PCR on the C1000 Thermal Cycler	63
Optimizing a Protocol for Faster PCR	63
Optimizing Annealing Temperature Steps with a Gradient	65
Optimizing PCR With Small Sample Volumes	66
Transferring Protocols from Another Thermal Cycler	66
Troubleshooting PCR Problems	66
Selecting Compatible Reaction Vessels and Sealing Options	67
Chapter 7. The C1000 Manager Software	69
Computer Requirements	69
Software Installation	70
Controlling Thermal Cyclers Using C1000 Manager Software	71
Copying and Running Protocols from a USB Key	75
User Preferences	76
Managing Users	78
Chapter 8. Advanced Functions	81
Logging Into or Logging Off the C1000 Thermal Cycler	81
Utilities Menu and Functions	83
Administrator Settings Menu	85
SYSTEM Folder Functions	86
Using Data Ports on the C1000 Thermal Cycler	86
Controlling S1000 Thermal Cyclers with the C1000 Cycler	86
Chapter 9. Maintenance and Troubleshooting	89
Cleaning and Maintaining the C1000 Thermal Cycler	89
Maintaining Sufficient Air Flow	91
Troubleshooting Error Messages on the C1000 Cycler	92
Appendix A: Preinstalled Protocols	97
Standard Protocols	97
Touchdown Protocol	98
Optimized Protocol Using iTaq Polymerase	98
Optimized Protocols Using iProof Polymerase	99
Optimized Protocol Using the iScript Reverse Transcriptase	100
Nested Primer Protocols	100
Appendix B: References	103
Appendix C: Ordering Information	105
Components of Bio-Rad's 1000-Series Thermal Cyclers	105
Accessories for the 1000-Series Thermal Cyclers	106
Index	107

1 Introduction to the C1000 Thermal Cycler

Read this chapter for information on setting up the C1000 thermal cycler.

- System overview (below)
- Reaction modules (page 4)
- Setting up the C1000 thermal cycler (page 5)
- Operating the reaction module lid (page 7)
- Renaming the C1000 thermal cycler (page 12)
- Setting up email notification (page 14)

System Overview

The front of the C1000 thermal cycler base (Figure 1) includes:

- **Reaction module bay** — holds the inserted reaction module
- **Reaction module locking bar** — locks reaction module in place
- **Control panel** — provides access to all the functions needed to create and run PCR protocols
- **USB A port** — connects to a USB key, computer mouse, or other USB devices
- **Air vents** — allow the thermal cycler to heat and cool quickly

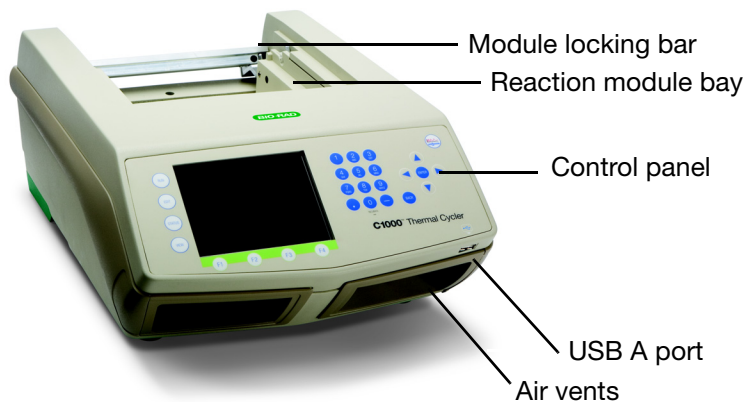

Figure 1. Frontal view of the C1000 thermal cycler.

The back panel of the C1000 thermal cycler includes data ports (Figure 2).

- **USB B port** — connects the C1000 thermal cycler to a computer
- **USB A ports** — connects up to three S1000 thermal cyclers to the C1000 thermal cycler. These ports can also connect to any USB key, mouse, keyboard, or barcode reader
- **Test port** — for service testing only

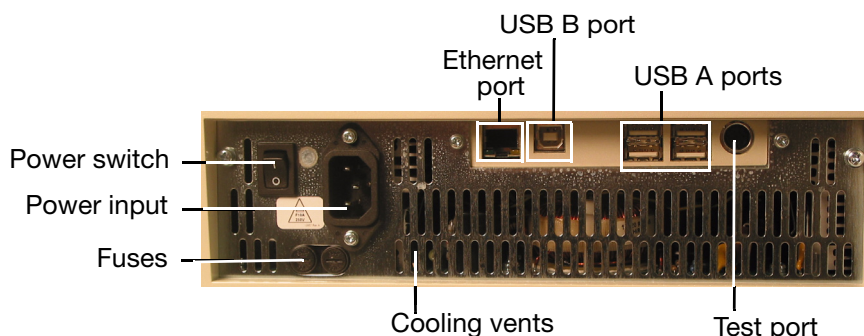

Figure 2. Back panel of the C1000 thermal cycler.

TIP: The USB A ports on the back of the C1000 thermal cycler can be used to connect a USB key, computer mouse, or up to three S1000 thermal cyclers.

The control panel on the C1000 thermal cycler provides access to all the functions needed to run the thermal cycler and includes the following components:

- **Liquid crystal display (LCD)** — displays the main menu and other screens
- **Command, function, alphanumeric and Protocol AutoWriter keys** — use these keys to enter commands and navigate various screens
- **USB A port** — connects a USB key for data transfer, mouse, keyboard, or barcode reader

The main screen is displayed after booting is complete. When the instrument starts up, it goes through two other screens: the black booting and the self-test screens. Figure 3 shows the components of the control panel.

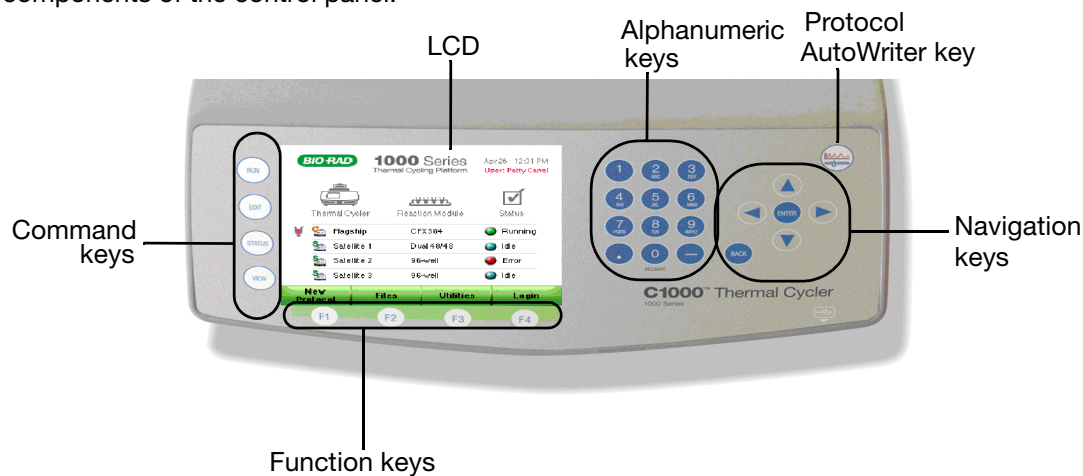
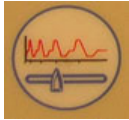

Figure 3. The control panel on the C1000 thermal cycler.

Function of the Control Panel Keys

The control panel of the C1000 thermal cycler contains five sets of keys with the functions listed in Table 6.

Table 6. Function of keys on control panel

Key	Function	Additional Notes
Command Keys		
RUN	Runs a protocol	
EDIT	Changes a protocol	
STATUS	Views the status of one or more running protocols on three screens	Pressing this key cycles through the main menu, protocol screen, and the instrument summary screen
VIEW	Switches between graphical and textual views of a protocol; also toggles through protocol and time remaining screens	
Function Keys		
F1, F2, F3, or F4	Activate the options associated with the four keys at the bottom of each screen	
Alphanumeric Keys		
1 through 9	Enter numbers or letters of the alphabet	Press each key multiple times to switch between numbers and associated letters
0, INCUBATE	Inserts a zero, infinity, or start instant incubation	
Protocol AutoWriter		
	Launches the Protocol AutoWriter software	
Navigation Keys		
Right arrow	Moves the cursor to the right	Expands folders in the file library
Left arrow	Moves the cursor to the left	Collapses folders in the file library
Up arrow	Moves the cursor up	
Down arrow	Moves the cursor down	
ENTER	Confirms a selection	
BACK	Deletes a letter, number, or word; also goes back to previous screens	

Reaction Modules

The C1000 thermal cycler is compatible with any 1000-series reaction module. The reaction modules come in three block sizes: the 96-, dual 48-, or 384-well block. Each block in the reaction module includes a fully adjustable heated lid that is capable of running reliably with a broad range of reaction vessels.

Recommended Sample Volumes

When using the C1000 thermal cycler, the maximum sample volume is determined by the type of reaction module used. Table 7 lists the recommended reaction volumes and the maximum amount of volume to be used with different reaction modules.

Table 7. Size and volume limit for 1000-series reaction modules

Number of Wells	Number of Blocks	Recommended Sample Volume (Upper Limit)
Dual 48/48	2	10–50 μ l (50 μ l limit)
96	1	10–50 μ l (50 μ l limit)
384	1	3–30 μ l (30 μ l limit)

Specifications of Reaction Modules

The reaction modules come in three block sizes. Specifications for each 1000-series reaction module are listed in Table 8.

Table 8. Reaction module specifications

Feature	96-Well Fast	Dual 48/48 Fast	384-Well
Sample capacity	96 x 0.2 ml tubes	2 x 48 x 0.2 ml tubes	1 x 384-well PCR microplate
Gradient direction	Back (upper temperature) to front (lower temperature) of block	Back (upper temperature) to front (lower temperature) of block	Back (upper temperature) to front (lower temperature) of block
Gradient temperature range	30–100°C	30–100°C	30–100°C
Gradient temperature differential	1–24°C	1–24°C	1–24°C
Gradient accuracy	$\pm 0.2^\circ\text{C}$ of programmed temperature at end rows	$\pm 0.2^\circ\text{C}$ of programmed temperature at end rows	$\pm 0.2^\circ\text{C}$ of programmed temperature at end rows
Gradient (end row) uniformity	$\pm 0.4^\circ\text{C}$ well-to-well (within row) within 10 sec of arrival at target temperature	$\pm 0.4^\circ\text{C}$ well-to-well (within row) within 10 sec of arrival at target temperature	$\pm 0.4^\circ\text{C}$ well-to-well (within row) within 10 sec of arrival at target temperature
Gradient calculator accuracy	$\pm 0.4^\circ\text{C}$ of the actual well temperature	$\pm 0.4^\circ\text{C}$ of the actual well temperature	$\pm 0.4^\circ\text{C}$ of the actual well temperature
Heated lid temperature	0–110°C	0–110°C	0–110°C
Average ramp rate	3.3°C/sec	3.0°C/sec	2.0°C/sec
Maximum ramp rate	5.0°C	4.0°C	2.5°C

Table 8. Reaction module specifications (continued)

Feature	96-Well Fast	Dual 48/48 Fast	384-Well
Temperature range	0–100°C	0–100°C	0–100°C
Temperature accuracy	±0.2°C of programmed target at 90°C	±0.2°C of programmed target at 90°C	±0.2°C of programmed target at 90°C
Temperature uniformity	±0.4°C well-to-well within 10 sec of arrival at 90°C	±0.4°C well-to-well within 10 sec of arrival at 90°C	±0.4°C well-to-well within 10 sec of arrival at 90°C

Each reaction module contains cooling fins for fast heating and cooling and a fully adjustable, heated lid.

- **Heated inner lid** — maintains the lid temperature to prevent condensation and evaporation
- **Sample/reaction block** — holds reaction vessels, including tubes and microplates
Figure 4 shows the lid and cooling fins for the 96-well reaction module

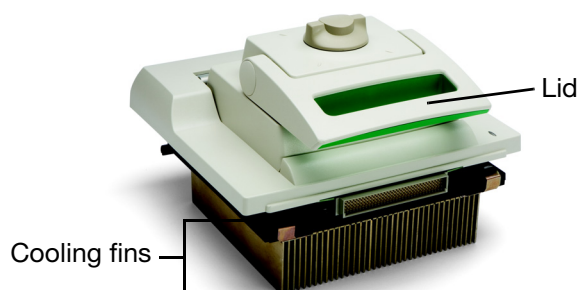
**Figure 4. The lid and cooling fins of a 96-well reaction module.**

The top of a reaction module lid includes a lid lever, lid force knob, and status LED (Figure 5).

- **Lid lever** — opens and closes the lid
- **Lid force knob** — sets lid force and seals the reaction
- **Status LED** — turns on to indicate that the block is selected or running

**Figure 5. A top view of a reaction module.**

Setting up the C1000 Thermal Cycler

The C1000 thermal cycler package includes:

- C1000 thermal cycler base
- Power cord

- 1 USB key
- Instruction manual
- Quick guide for system installation
- C1000 Manager software installation CD

Reaction modules for use with the C1000 thermal cycler are shipped in separate packaging.

Remove all packaging materials and store them for future use. If any item is missing or damaged, contact your local Bio-Rad office.

Place the C1000 thermal cycler base on a flat, dry surface with sufficient cool airflow to run properly. The instrument can run in two modes: stand-alone or software-controlled. When running the system under software-controlled mode, make sure there is sufficient space for a computer during setup.

To insert either a 96-, dual 48-, or 384-well reaction module into the reaction module bay of the thermal cycler base, follow these instructions:

1. With the locking bar in the down position and the lid lever of the reaction module pointing to the front, lift the reaction module into the reaction module bay (Figure 6). Leave about 1–2 cm of space in front of the module.



Figure 6. Inserting the reaction module into the bay.

2. Pull the locking bar up to lock the reaction module in place (Figure 7). There should be no space at the front of the module when it is locked into the C1000 thermal cycler base.

TIP: Store the reaction module in the base when it is not in use.



Figure 7. Locking the reaction module in place.

3. Plug the supplied power cord into the appropriate electrical outlet.
4. Turn on the thermal cycler using the power switch on the back panel of the thermal cycler base.

NOTE: Before operating the thermal cycler, be sure to read the safety specifications (“Safety and Regulatory Compliance” on page iv) and operating requirements.

5. When the C1000 thermal cycler starts, it runs a self-test to verify proper functions, and then displays the main menu. Use the main menu to begin operating the thermal cycler.

To remove the reaction module from the thermal cycler base, follow these instructions:

1. **Turn off** the thermal cycler.
2. Unlock and release the reaction module by pushing the locking bar down (Figure 8).
3. Carefully lift the reaction module out of the bay (Figure 8).

WARNING! Cooling fins may be hot immediately after running a protocol or incubation. Before lifting the reaction module, make sure the fins are cool.

4. After removing the reaction module from the C1000 thermal cycler, store it on a clean, flat surface where it cannot get bumped, scraped, or dropped.

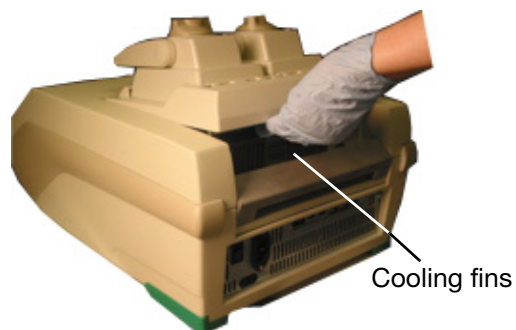

Figure 8. Lifting the reaction module out of the bay.

Operating the Reaction Module Lid

The inner lid of the reaction module applies heat and force to the reaction vessel lids (caps or tape) to produce consistent and successful reactions. Heating the inner lid prevents condensation, while applying force seals the reaction to prevent evaporation.

WARNING! After a run, the heated inner lid can remain hot. Use caution when opening and closing the lid.

To open the lid, use the following steps:

1. Turn the lid force knob counterclockwise to release the inner lid (Figure 9).

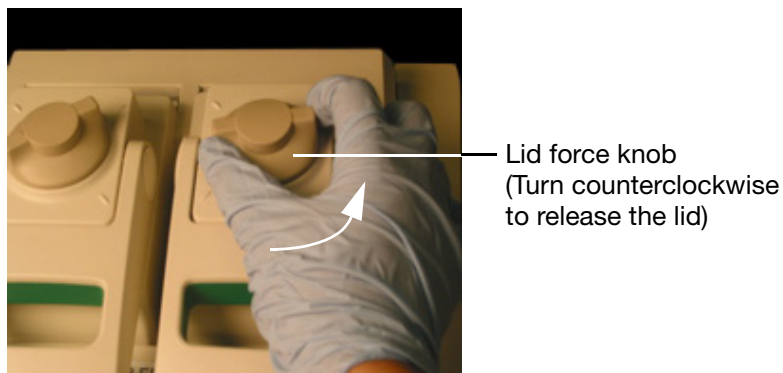

Figure 9. Turn the lid force knob counterclockwise to release the inner lid.

2. To open the lid, push the lid lever back and then lift it up (Figure 10).

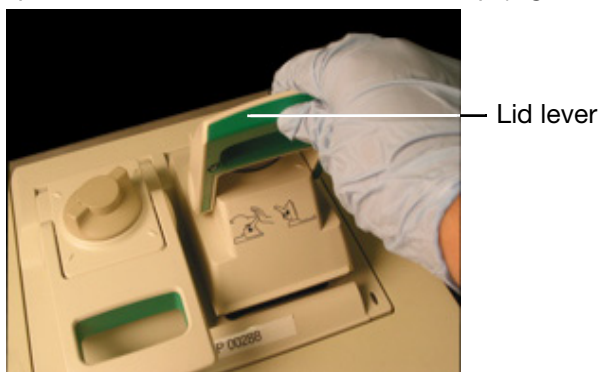

Figure 10. Lift the lid lever up to open the lid.

3. Lift the lid lever completely until the reaction module stays open without assistance.

To close the lid, follow these steps:

1. Push the lid lever down (Figure 11), making sure that the front of the lid is secured beneath the housing, and then lock it in place.



Figure 11. Push the lid lever down.

2. Adjust the lid force by turning the lid force knob (Figure 12).
 - Turn the knob 1/4 clockwise (to the right) to increase the lid force
 - Turn the knob 1/4 counterclockwise (to the left) to decrease the lid force

Adjust the lid force to a similar setting each time by turning it to the same position.

NOTE: The position marks on the lid indicate 1/4 turns.

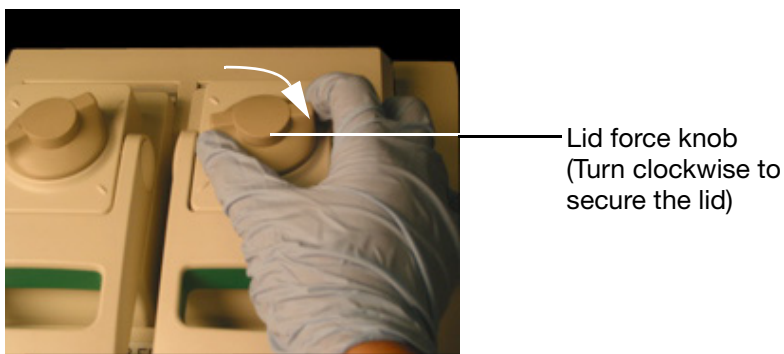

Figure 12. Adjust the lid force by turning the lid lever.

Loading Sample Vessels into the Reaction Block

To ensure uniform heating and cooling of samples, vessels must be in complete contact with the reaction block. Adequate contact is achieved by:

- Confirming that the block is clean before loading samples
- Firmly pressing the individual tubes or the microplate into the block wells

TIP: When using one or a few tubes, make sure to place them in the center of the block to ensure uniform thermal cycling of all samples. Use the tube frame (catalog #184-9000) or load at least one empty tube in each corner of the block to ensure that the lid exerts even pressure on individual tubes.

Main Menu

The main menu provides access to all thermal cycler operations and displays the status of the reaction module and the name of the thermal cycler.

In the example shown in Figure 13, the main menu window displays the date and time, name of logged-in user (**GREGOR**), name of the instrument (**EV000001**), reaction module (**96 well**), current status (**Idle**), and main menu keys.

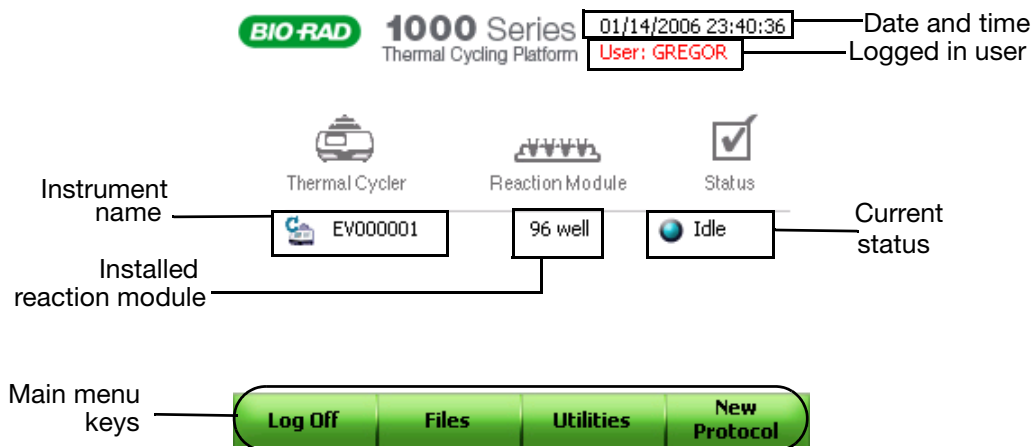

Figure 13. The main window of the C1000 thermal cycler.

NOTE: The names and functions of keys change with each screen.

To initiate the functions in the main menu, press the associated function keys (**F1** through **F4**) or press the keys on the control panel using a computer mouse. Below are choices of functions:

- **New Protocol (F4)** — creates a new protocol (page 19)
- **Utilities (F3)** — opens the Utilities menu (page 83)
- **Files (F2)** — for viewing the files and folders in the file library (page 54)
- **Log in (F1)** — for logging into the C1000 thermal cycler. Once you log in, the key name changes to Log Off (page 81)

The File Library

Many functions begin with choosing a protocol from the file library. For example, before running or editing a protocol, select the desired protocol file in the file library:

- Press **RUN** to run a protocol

- Press **EDIT** to edit a protocol

To open the file library, select **Files** in the main menu. The file library provides access to multiple folders (Figure 14).

- **Thermal cyclers protocol folder** — contains protocols stored on the thermal cycler, including the **MAIN** folder that stores the preinstalled protocols. The instrument's serial number is used as the name of the thermal cycler, unless the thermal cycler is renamed by the user

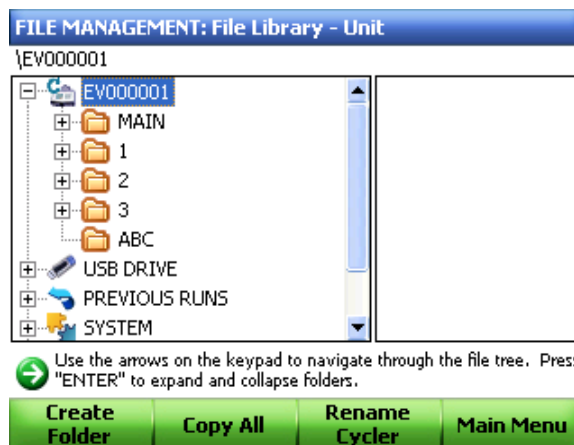

Figure 14. The file library of the C1000 thermal cycler.

- **PREVIOUS RUNS** folder — contains a list of all previously run protocols (Figure 15)

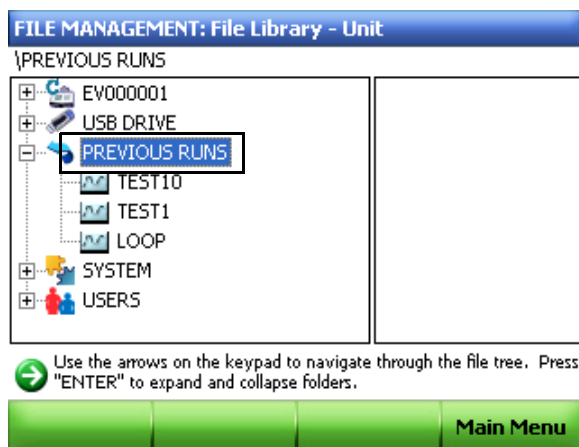

Figure 15. The PREVIOUS RUNS folder.

- **SYSTEM** folder — contains run logs, real-time PCR data, and templates (Figure 16)

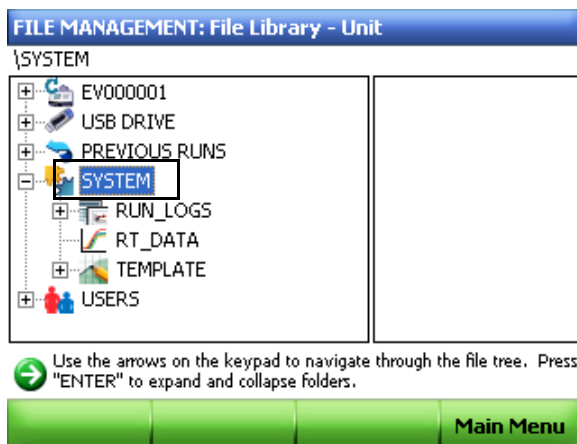

Figure 16. The SYSTEM folder is highlighted.

- **USERS** folder — contains folders created by users for personal protocol storage (Figure 17). The USERS folders can be accessed by everyone, but only the user who is logged in can edit, delete or save into these folders

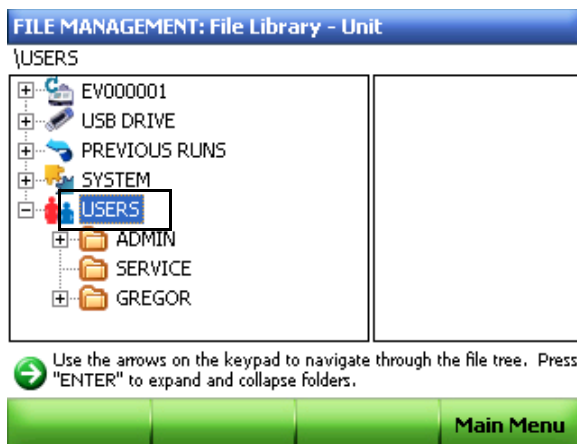

Figure 17. The USERS folder is highlighted.

- Attached folders (optional) — contain the data on attached USB keys or S1000 thermal cyclers. Figure 18 shows three connected S1000 thermal cyclers

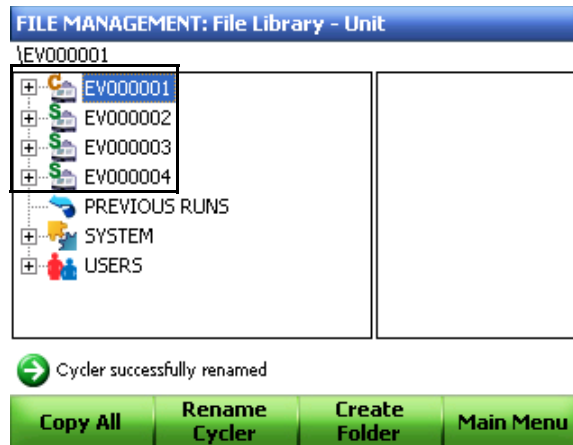

Figure 18. Three S1000 thermal cyclers are connected to the C1000 thermal cyclers.

Renaming the C1000 Thermal Cyclers

Each C1000 thermal cycler is initially named using the serial number of the thermal cycler base. Once logged in, an Administrator can rename any thermal cycler for easy identification.

To rename a C1000 thermal cycler, follow these steps:

1. Select **Files** to open the file library and select **Rename Cycler** (Figure 19).

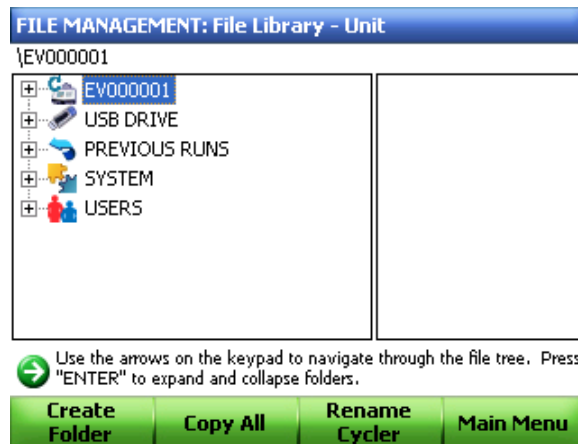

Figure 19. Click Rename Cycler to rename the instrument.

2. Type in a new name in the text box using the alphanumeric keys (Figure 20).

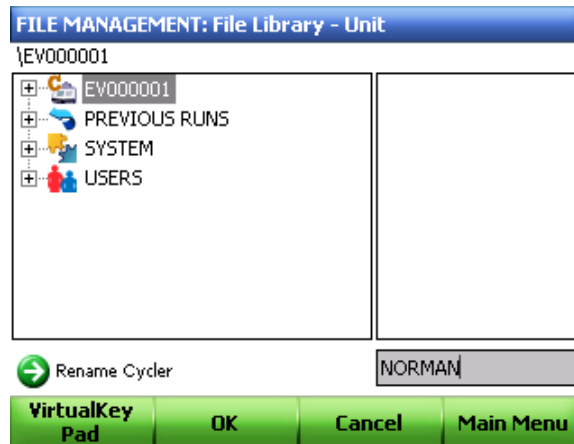

Figure 20. Type in the name of the thermal cycler.

Alternatively, select **Virtual Key Pad** to type a name (Figure 21). Use the arrow keys to highlight the appropriate letters and numbers, and then press **ENTER** to select them.

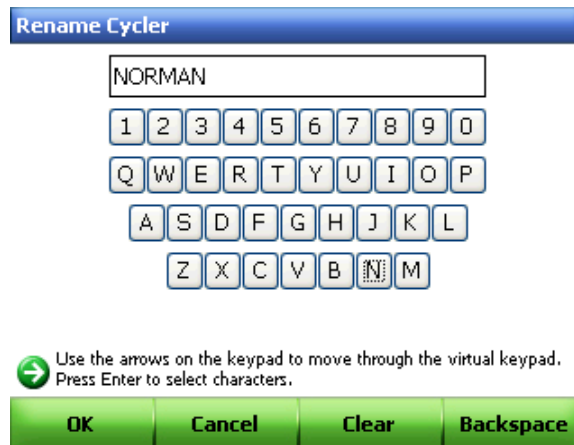

Figure 21. The virtual key pad can be used to enter the new cycler name.

3. Select **OK** to accept the new cycler name.

Setting Up Email Notification

A run log report can be emailed directly to any computer with Internet access. To configure the outgoing email from the C1000 thermal cycler, use the following instructions:

1. Select **Log In (F1)** on the main menu to log in to the thermal cycler as the Administrator (Figure 22).

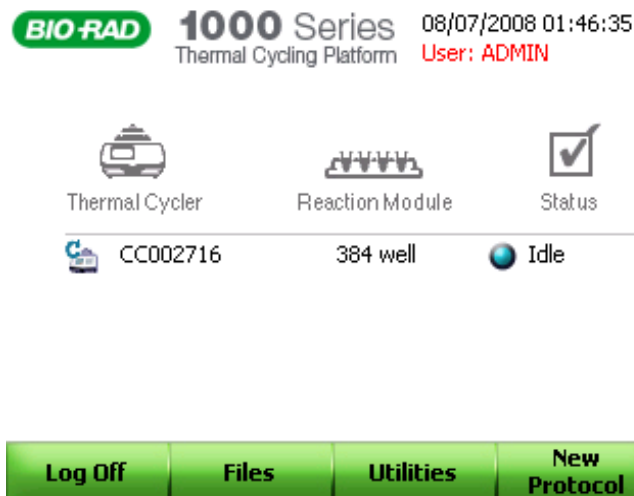

Figure 22. Start-up screen.

NOTE: The logged in user name appears under the date and time when you return to the main window.

2. Select **Utilities (F3)** on the main screen to launch the **Utilities Menu**.
3. Select **5 (Administrator Settings)** on the **Utilities Menu** (Figure 23).

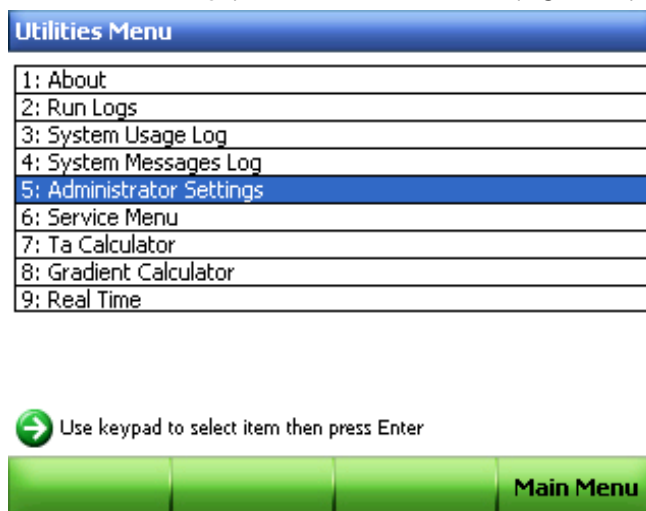

Figure 23. The Utilities Menu.

- In the **Administrator Settings Menu**, select **9 (SMTP Server Settings)** as shown in Figure 24.

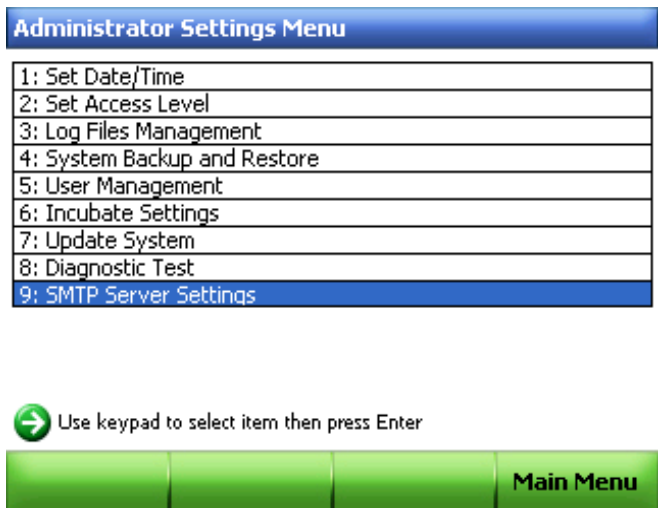

Figure 24. The Administrator Settings Menu.

- Contact your Network Administrator to obtain the SMTP server name.
NOTE: The SMTP server name is provided by your ISP.
- Select **Add Server Name (F1)** as shown in Figure 25.



Figure 25. SMTP server setup.

- Type the name of the server in the text box using the virtual keypad.

8. Select **Save (F1)** to save the name of the SMTP server (Figure 26).

SMTP Server Information

Please contact your Network Administrator for proper SMTP server name information

SMTP Server Names:

Current SMTP Server: **none**

Press "Save" or "Enter" to save new server name

Figure 26. Saving server name.

9. The added server name will appear in the SMTP Server Names pull-down menu as shown in Figure 27.

SMTP Server Information

Please contact your Network Administrator for proper SMTP server name information

SMTP Server Names:

Current SMTP Server: **none**

Set current SMTP server name

Figure 27. Added server name.

10. Select **Set Current Server (F3)** to set the current server to be used for email.

11. Use the arrow keys to select **Test Current Server** and press **ENTER** (Figure 28).

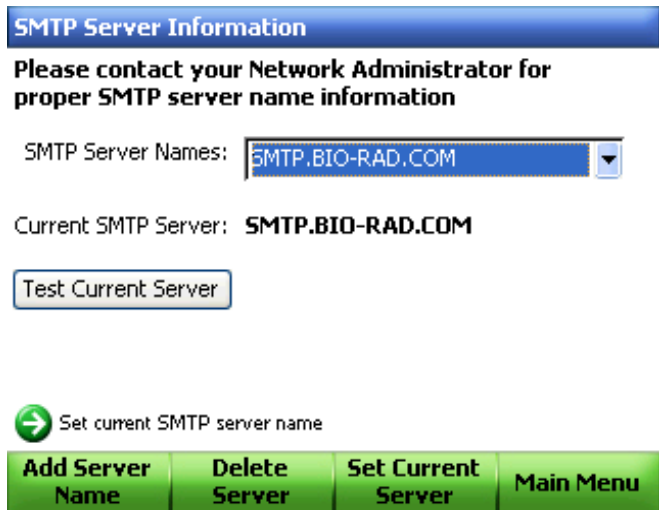

Figure 28. Test the current server.

12. Type an email address in the text box and select **Test Server (F1)** as shown in Figure 29.



Figure 29. Enter an email address to test the current server.

13. The C1000 thermal cycler will send an email to the entered address as a test of the SMTP server configuration.

2 Creating, Editing, Naming, and Saving Protocols

Read this chapter for information on creating and editing protocols.

- Creating a new protocol or editing an existing protocol (below)
- Sample volume and lid temperature (page 31)
- Naming a protocol (page 33)
- Saving a protocol (page 33)

Creating a New Protocol or Editing an Existing Protocol

To create or edit a protocol:

1. Select **New Protocol** from the main menu, or press **EDIT** and select the protocol to be modified.

A protocol opens in **graphical** view (Figure 30).

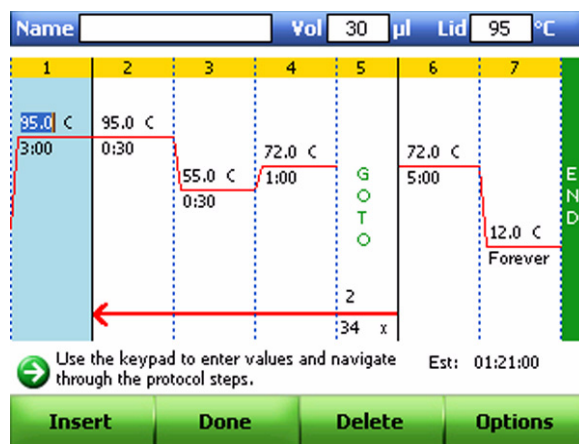

Figure 30. The template protocol in graphical view.

Press **View** to switch to textual view (Figure 31). Press **View** again to toggle between the viewing modes.



Figure 31. A template protocol in textual view.

2. Using the arrow keys, navigate to the desired field.
3. Press the alphanumeric keys to enter a new value for any parameter highlighted.
4. Press **RUN** to run the protocol without saving it (page 35). Alternatively, select **Done** to choose a folder location and save the protocol (page 33).

Protocol Parameters

Table 9 includes a list of all the parameters for temperature and gradient steps, with limits and range of the parameters.

Table 9. Protocol steps and parameters of the C1000 thermal cycler

Step Name	Parameters and Ranges	Description
Temperature	Temperature in °C : The target temperature between 0.0 and 100.0°C in tenths of a degree	Instructs the thermal cycler to ramp to the target temperature, and hold that temperature for the specified amount of time
	Hold time : The hold time between 1 sec and 18 hr in the format of hr:min:sec. To enter an infinite hold, press the ∞ (infinite, 0) key	

Table 9. Protocol steps and parameters of the C1000 thermal cycler (continued)

Step Name	Parameters and Ranges	Description
Gradient Range	<p>Lower: The lower temperature in the gradient. Enter a number between 30.0 and 99.0°C in tenths of a degree</p> <p>Upper: The upper temperature in the gradient. The maximum temperature is 100°C. Enter a temperature within 24.0°C of the lower temperature</p> <p>Time: The hold time between 1 sec and 18 hr in the format of hr:min:sec. To enter an infinite hold, press the ∞ key (infinite, 0) key</p>	Instructs the thermal cycler to ramp to the target temperature gradient across the block, and hold that temperature gradient for the specified amount of time
Increment	A temperature from -10.0 to 10.0°C per cycle in tenths of a degree	Applies only to a temperature step (see “Changing Target Temperature and Hold Time” on page 22). Instructs the thermal cycler to increment (change) the target temperature of a step with each cycle, where a positive number increases the temperature and a negative number decreases the temperature
Ramp Rate	A number from 0.1 to 5°C per sec	Applies only to a temperature step (see “Changing the Ramp Rate” on page 27). Instructs the thermal cycler to ramp to the target temperature at the specified ramp rate in that step
Extend	A time from -60 to 60 sec per cycle	Applies to both temperature and gradient steps (see “Adding or Removing an Extend Time” on page 27). Instructs the thermal cycler to extend the hold time with each cycle. A positive number increases the hold time and a negative number decreases the hold time
Beep	(No parameters)	Applies only to a temperature step (see “Adding or Removing a Beep” on page 28). Instructs the thermal cycler to beep to signal that the thermal cycler has reached the target temperature for that step

Changing Target Temperature and Hold Time

To change the target temperature and hold time in a temperature step, follow these instructions:

1. Select a step in the protocol.

The default template for a new protocol opens (Figure 32). Notice that each temperature step includes a target temperature and a hold time.

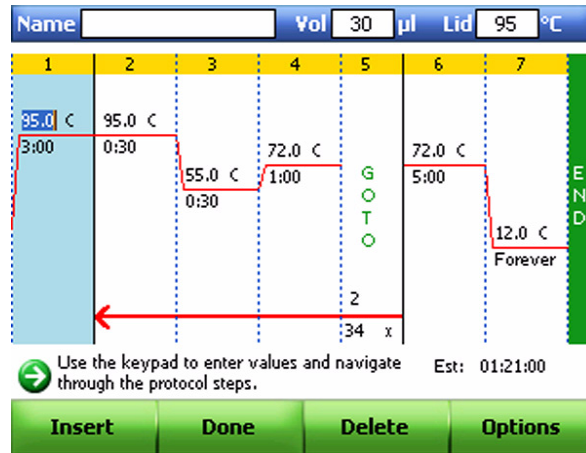

Figure 32. A default template for a new protocol.

2. Press the arrow keys to select (highlight) a parameter.
3. Use the alphanumeric keys to enter a new value for the target temperature or hold time.

TIP: To change between graphical and textual views, press **VIEW**.

The target temperature in step 3 has been changed to 65°C (Figure 33).

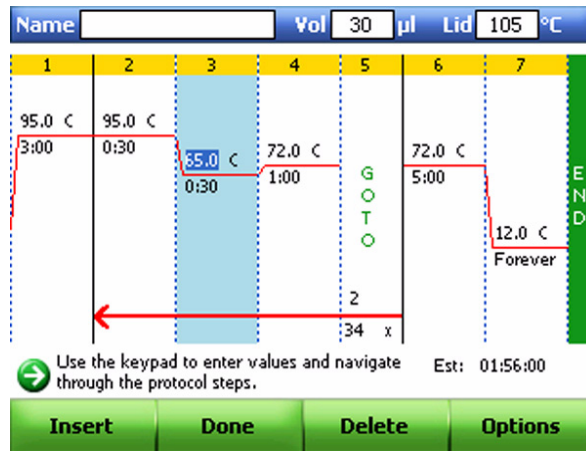

Figure 33. The target temperature changed from 55 to 65°C.

Inserting a Protocol Step

Insert a protocol step if a new temperature, GOTO, or gradient step is needed. Follow these instructions to insert a step to the **right** of a preexisting protocol step:

1. Select a step to the left of where the new step is going to be inserted.

Then click **Insert**. Figure 34 shows that step 2 is selected in the protocol.

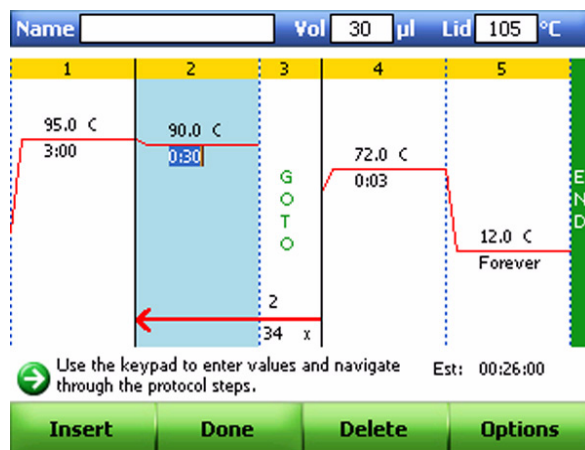

Figure 34. Insert a new step on the right side of step 2.

2. Choose the type of step to insert.

Select **Temp** to insert a temperature step, **GOTO** to insert a GOTO step, or **Gradient** to insert a gradient step.

3. Select and edit the parameters in the new step.

The new step has a default target temperature of **50°C** and a default time of **30 sec** (0:30). To modify the parameters in the new step, see “Changing Target Temperature and Hold Time” on page 22. Figure 35 shows an example of a protocol where a temperature step is inserted inside a GOTO repeat.

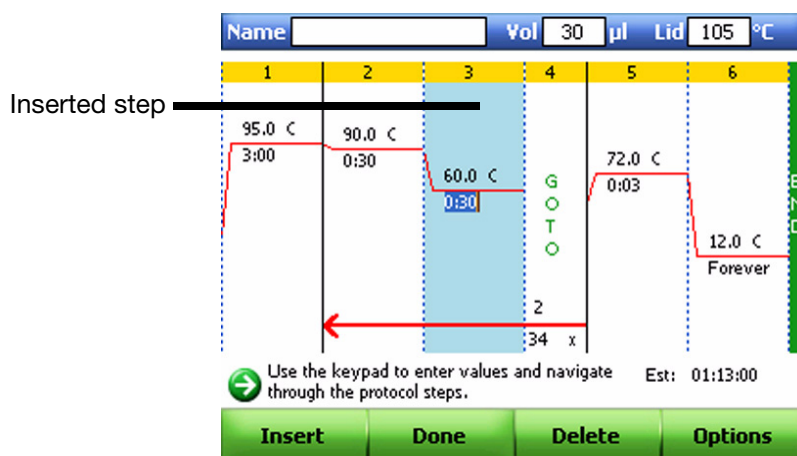

Figure 35. A temperature step inserted inside a GOTO repeat.

Deleting a Protocol Step

To permanently remove a step from a protocol:

1. Select the step to be deleted.

Step 6 is selected in the example shown on Figure 36.

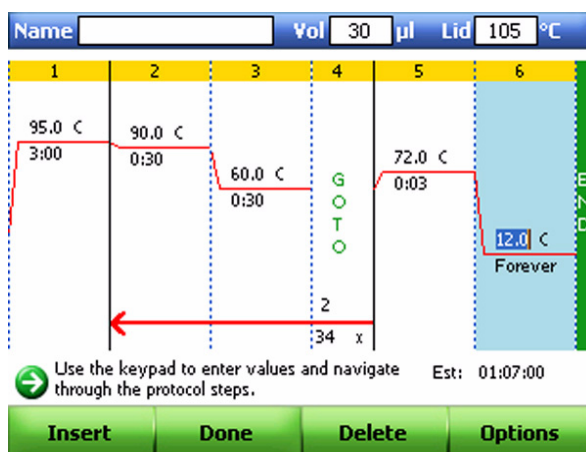

Figure 36. Step 6 selected for deleting.

2. Select **Delete** to remove the selected step.
Once step 6 has been deleted, step 5 becomes the final step in the protocol (Figure 37).

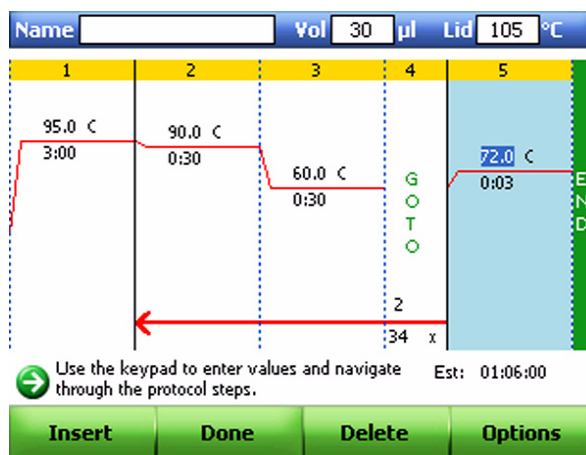

Figure 37. Step 5 becomes the final step in the protocol when step 6 gets deleted.

Adding or Removing a Temperature Gradient

To add a temperature gradient to a temperature step:

1. Select a step in the protocol and click **Options**.

The **Step Options** window opens (**Figure 38**).

Figure 38. The Step Options window.

- Using the alphanumeric keys, enter a value in the **Gradient Range** field.

NOTE: A gradient range must be between 1 and 24°C. The highest temperature in the gradient is the sum of the lower temperature and the gradient range.

Figure 39 shows an example of a protocol where the gradient range is 20°C and the low temperature is 55°C. Thus, the upper temperature is 75°C. Once the gradient range is entered, the Step Options screen displays the gradient distributed across the rows of wells in the block. The gradient is displayed across a 96-well block from the back (row A, upper temperature) to the front (row H, lower temperature).

Figure 39. The Step Options screen displays the gradient distributed across the rows of wells in the block once the gradient range is entered.

NOTE: A gradient step can also include an **Extend** parameter, but does not have to include parameters such as **Increment**, **Beep** or **Ramp Rate**.

- Click **OK** to continue.
- Review the gradient selection.
- Once a step has a gradient, the upper and lower temperatures can be edited in the graphical or textual view without opening the **Step Options** screen.

Figure 40 shows an example of a protocol where the gradient range is from 55 to 75°C.

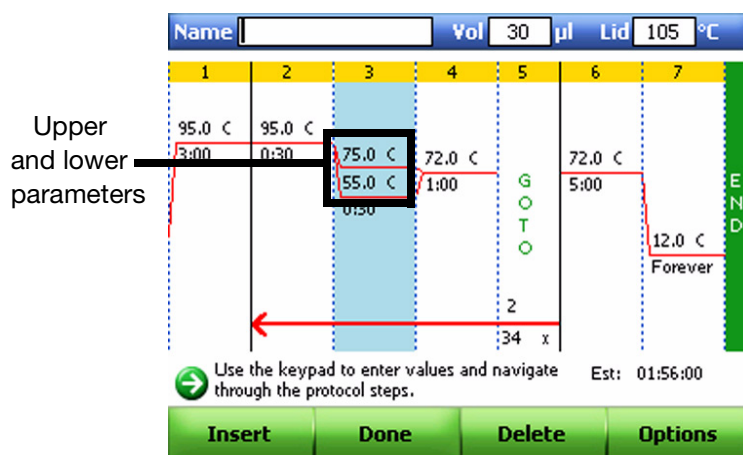

Figure 40. The gradient range changed from 55 to 75°C.

To remove the temperature gradient:

1. Select the gradient step and then select **Options**.
The **Step Options** window opens.
2. Select the **Gradient Range** and delete the range by pressing **BACK**.
3. Select **OK** to confirm.

Adding or Removing a Temperature Increment

An increment raises or lowers the target temperature for a step with each cycle. To add or remove a temperature increment:

1. Follow steps 1–4 of “Adding or Removing a Temperature Gradient” on page 24, but change the value in the **Increment** field instead.
2. Review the increment in the textual view of a protocol.
Step 3 of the protocol in Figure 41 has an increment.



Figure 41. A temperature increment added in step 3 of the protocol.

3. To remove an increment, select a step in the protocol and then select **Options**.

The **Step Options** window opens. Delete the increment temperature by pressing **BACK**.

4. Select **OK** to confirm.

Changing the Ramp Rate

To emulate a thermal cycler that runs at a slower ramp rate than the C1000 thermal cycler, change the ramp rate of the appropriate protocol step. To modify the ramp rate:

1. Follow steps 1–4 of “Adding or Removing a Temperature Gradient” on page 24, but change the value in the **Ramp Rate** field instead.
2. Review the ramp rate in the textual view of a protocol.

Figure 42 shows a ramp rate change in step 3 of the protocol.

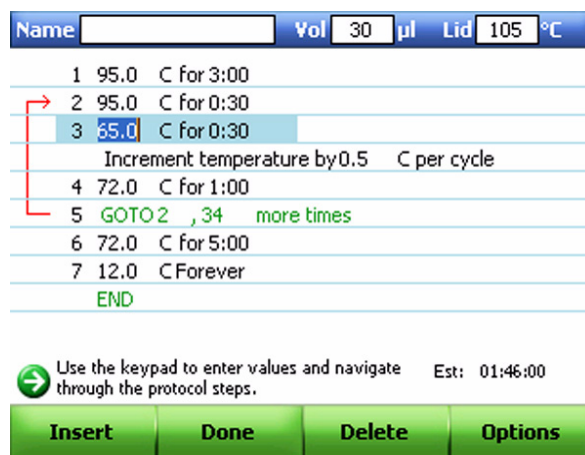

Figure 42. An example of a ramp changed in step 3 of the protocol.

3. To remove a ramp rate, select a step in the protocol and then select **Options**.
The **Step Options** window opens. Delete the existing ramp rate by pressing **BACK**.
4. Select **OK** to confirm.

Adding or Removing an Extend Time

To increase or decrease the hold time with each cycle, add an extend time to a protocol step. To add or remove an extend time:

1. Follow steps 1–4 of “Adding or Removing a Temperature Gradient” on page 24, but change the value in the **Extend** field instead.
2. Review the extend time in the textual view of a protocol.

Figure 43 shows protocol step 3 with an extend time.



Figure 43. An extend time is added to step 3 of the protocol.

3. To remove an extend time, select a step in the protocol and then select **Options**. The **Step Options** window opens. Delete the extend time value by pressing **BACK**.
4. Press **OK** to confirm.

Adding or Removing a Beep

A beep is a sound that the thermal cycler emits when it reaches a protocol step. To add or remove a beep:

1. Follow steps 1–4 of “Adding or Removing a Temperature Gradient” on page 24, but instead press the arrow keys to highlight the word “Beep”.
2. Press **ENTER** to select the Beep box and press **OK** to confirm (Figure 44).

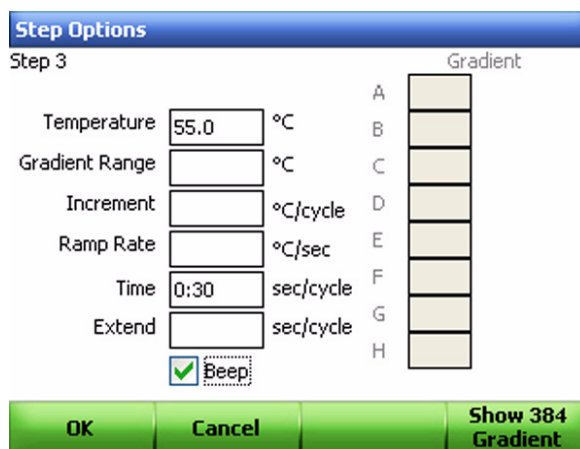

Figure 44. Select the Beep box.

3. View the beep in the textual view of the protocol.

Figure 45 shows step 3 of the protocol with a beep added to it.



Figure 45. A beep added to step 3 of the protocol.

- To remove the beep, select a step in the protocol and then select **Options**.
The **Step Options** window opens. Delete the beep by pressing **ENTER** after selecting the **Beep** box.
- Press **OK** to confirm.

Changing Parameters in a GOTO Step

The GOTO step instructs the thermal cycler to repeat a set of steps in a loop. This step creates a cycle in the PCR experiment. To change parameters in a **GOTO** step, follow these instructions:

- Select a **GOTO** step in the graphical or textual view of the protocol.
Figure 46 shows an example where the step parameters include a **GOTO** step 1, and 34 additional repeats. Notice that the **GOTO** arrow points to step 1.

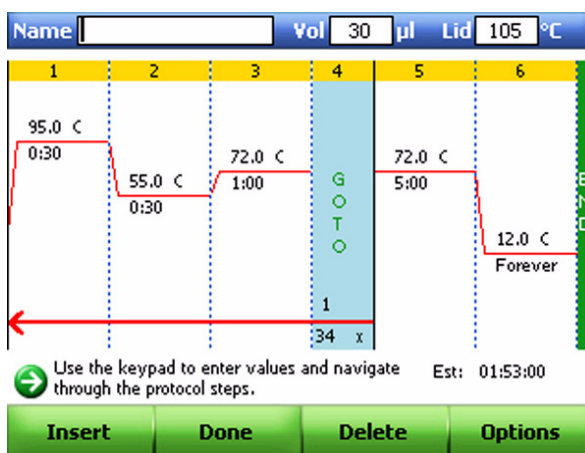

Figure 46. A protocol that includes a GOTO step 1 and 34 additional repeats.

- Press the arrow keys to select the number in the GOTO step.

In Figure 47, the GOTO step is changed from step 1 to step 2. Notice that the GOTO arrow moved to step 2.

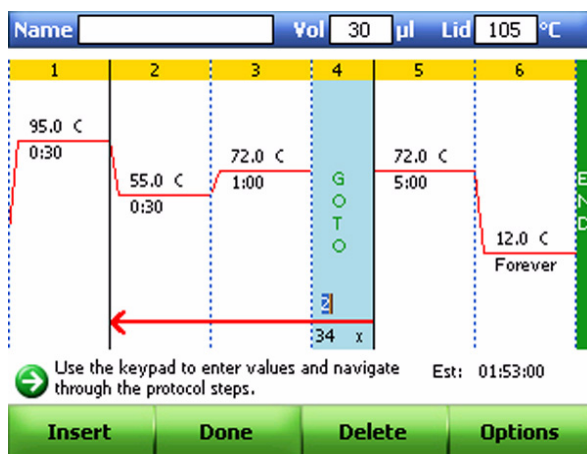

Figure 47. The GOTO step is selected in this example.

3. Change the GOTO loop to adjust the number of repeated sets of steps. Figure 48 shows the number of GOTO loops being changed from 34x to 35x.

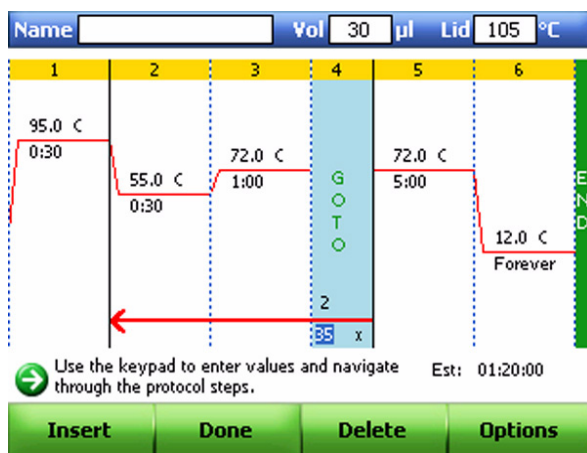

Figure 48. The GOTO loops changed from 34x to 35x.

4. View the changes in the GOTO parameters in textual or graphical view.

Figure 49 shows the protocol in textual view.

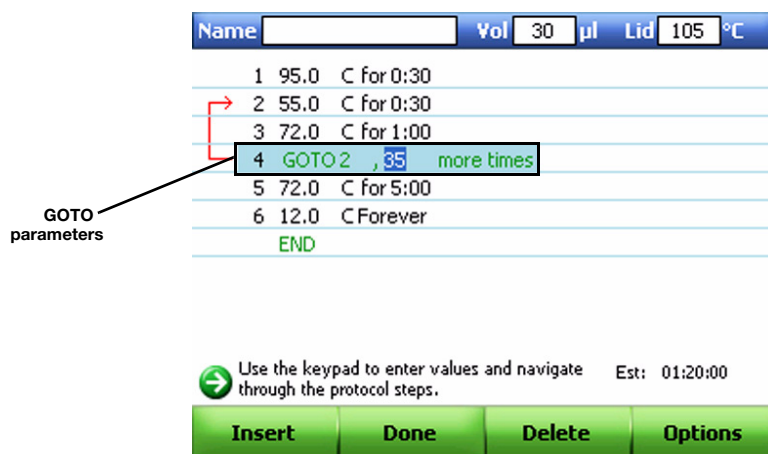

Figure 49. Protocol with GOTO parameters shown in textual view.

Sample Volume and Lid Temperature

- **Sample volume** — determines the temperature control mode, which influences the amount of time the samples are held at the target temperature
- **Lid temperature** settings — determine the temperature of the heated lid and when it cuts off. If the temperature is too high, the sample temperature might rise above the target temperature

The C1000 thermal cycler provides three ways of managing and entering sample volume and lid temperature settings:

- Change the setting when creating and editing the protocol (page 32)
- Change the default system settings in the **Utilities Menu** (page 83)
- Change the setting while initiating a run (page 35)

Temperature Control Modes

The C1000 thermal cycler uses one of two temperature control modes to determine when the sample reaches the target temperature:

- **Calculated mode** — the thermal cycler calculates the sample temperature based on the sample volume when a sample volume between 1 and 50 µl is entered for 96- or dual 48-well reaction modules or a volume between 1 and 30 µl is entered for the 384-well reaction module. The calculated mode is recommended, because it most accurately represents the actual sample temperature
- **Block mode** — when a sample volume of zero (0) µl is entered, the thermal cycler assumes that the sample temperature is the same as the measured block temperature

Choosing Lid Temperature

The adjustable heated lid of the C1000 thermal cycler allows the user to control the lid temperature and force. Heating the lid prevents condensation from forming inside the reaction wells.

When the C1000 thermal cycler is running, the heated lid maintains the temperature specified for the protocol being run. Without a heated lid, water can be lost from the reagents to condensation, concentrating the reactants in the tube or plate.

The default lid temperature of the C1000 thermal cycler is 105°C for 96- or dual 48-well reaction blocks and 95°C for 384-well blocks.

NOTE: When the block is running an infinite hold at a temperature below the **Cutoff** parameter, the lid heater maintains 31.0°C. The default **Cutoff** setting is 30.0°C. To change the default **Cutoff**, select **Utilities > Administrator Settings > Incubate Settings**, while logged in as an Administrator.

Changing Sample Volume

To change the sample volume for a protocol:

1. Use the arrow keys to move the cursor to the **Vol** field.
2. Using the alphanumeric keys, enter the sample volume in the **Vol** field (Figure 50).
To delete an existing volume and replace it with a new volume, press **BACK**. Then type the new volume using the alphanumeric keys.

NOTE: Entering a value between 1 and 50 in the volume (**Vol**) field selects **Calculated Temperature** control mode, which is the standard mode. Entering **zero (0)** in the volume (**Vol**) field selects **Block mode**. Calculated mode is the recommended mode because it most accurately represents the actual sample temperature (see “Temperature Control Modes”).

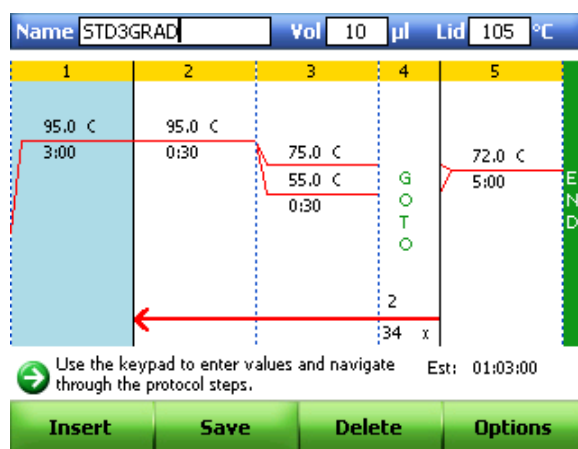

Figure 50. Enter the sample volume in the Vol field.

Changing Lid Temperature

When using a 96- or dual 48-well reaction block, the recommended lid temperature is 105°C. When using a 384-well block, the recommended lid temperature is 95°C.

To change the default lid temperature:

1. Use the arrow keys to move the cursor to the **Lid** field.
2. Using the alphanumeric keys, enter the lid temperature in the **lid** field.

Naming a Protocol

A new protocol requires a name, which can later be changed, if so desired. When editing an existing protocol, the user has the option of renaming the protocol. Renaming the protocol does not remove the original protocol.

To name a protocol, follow these steps:

1. Use the arrow keys to move the cursor to the **Name** field.
2. Using the alphanumeric keys, enter the protocol name in the **Name** field.

To delete an existing name and replace it with a new name, press **BACK**. Then type the new name using the alphanumeric keys.

NOTE: A protocol name can include up to eight letters and numbers. It cannot be duplicated in the same folder or contain spaces, dots, or dashes.

Saving a Protocol

To save a new or modified protocol:

1. Select **Done** once the protocol has been edited and is ready to be saved (Figure 51).
Saving the protocol with the same name replaces the original protocol. Saving the protocol with a new name adds a new protocol, and does not remove the original protocol or its name.

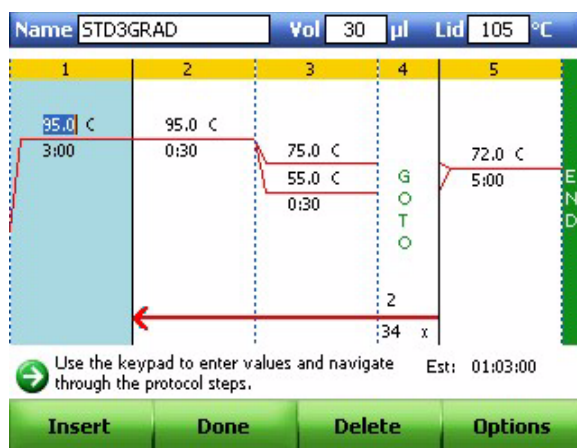

Figure 51. Press Done to start saving the protocol.

2. To save the protocol with a new name, select **Edit Filename** and type in a new name.
3. Select the destination folder using the arrow keys.

In Figure 52, the **EVA** folder is selected. Click **Create Folder** to create a new destination folder, if desired.

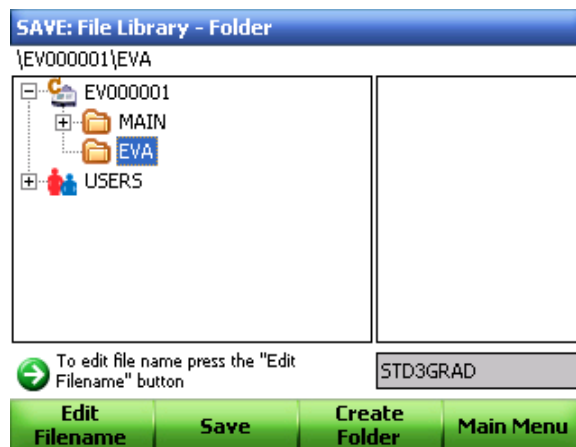

Figure 52. The **EVA** folder is selected in this example.

4. Select **Save**.

In Figure 53, the file **STD3GRAD** is stored in the **EVA** folder.

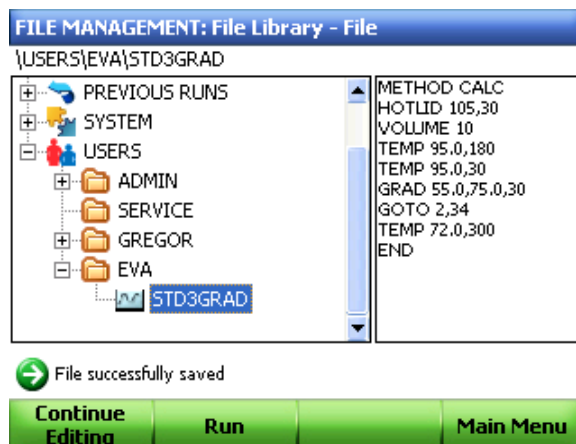

Figure 53. The **STD3GRAD** file is saved in the **EVA** folder.

5. Select a new function (optional).

Once the protocol is saved in a folder, there are three options:

- Proceed to make changes to the protocol by clicking **Continue Editing**
- Run the protocol by pressing **RUN**
- Return to the main menu by selecting **Main Menu**

3 Running Protocols

Read this chapter for instructions on running protocols.

- Preparing to run a protocol (below)
- Monitoring a run (page 38)
- Pausing and resuming a run (page 39)
- Skipping steps in a protocol (page 40)
- Canceling a run (page 41)
- Incubating samples (page 43)

Preparing to Run a Protocol

To start a run, use one of the following methods:

- Select a protocol from the file library, then press **RUN** or **ENTER**
- Select a protocol in the **PREVIOUS RUN** folder, then press **RUN** or **ENTER**
- Open the file library to select a protocol, then press **RUN** or **ENTER**
- Edit a protocol, then press **RUN**
- Create a new protocol, then press **RUN**

For detailed instructions on running a protocol, follow these steps:

1. Press **RUN** from any screen.

The file library opens as shown in Figure 54.

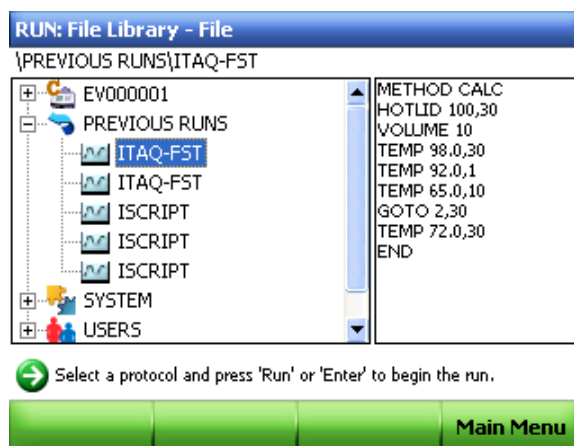

Figure 54. The ITAQ-FAST protocol selected from the file library.

2. Using the arrow keys, select a protocol.

3. Press **RUN** or **ENTER** again. The **System Status** screen opens.

When more than one block is connected to the C1000 thermal cycler, choose the blocks that are being used to run the protocol. In Figure 55, a dual 48/48 reaction module is installed on the C1000 thermal cycler.

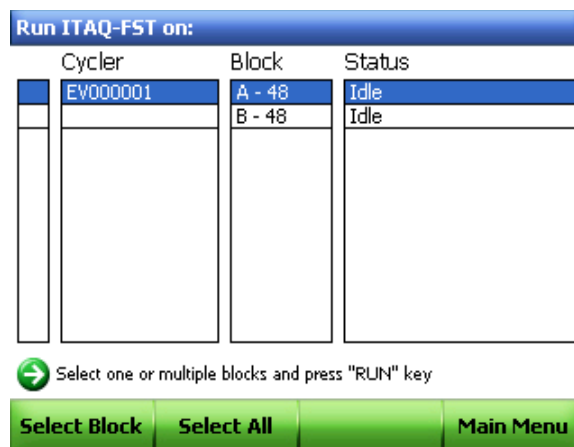

Figure 55. A dual 48/48 reaction module installed on a C1000 thermal cycler.

4. Select the reaction module block(s) on which to run the protocol by highlighting the instrument name and pressing **ENTER**, or use the **Select Block** or **Select All** options to select single or multiple blocks, respectively.

A checkmark appears to the left indicating a block is indicated.

5. Press **RUN**.

When running a protocol on more than one block, determine whether you want to start blocks individually or simultaneously.

- **Option A** – Select **Start all blocks running at once** when running the protocol on all blocks at the same time

- **Option B** – Select **Confirm each run one at a time** when running the protocol on more than one block at a time or when starting the runs at different times

After selecting one of the options, press **OK** to begin the run. In Figure 56, the protocol has started running on all of the blocks at the same time.

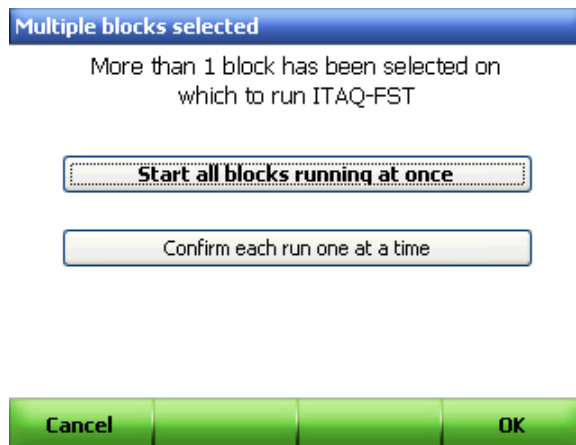

Figure 56. Multiple blocks running the same protocol at the same time.

6. Confirm or change the run parameters before starting the run.

The sample volume and lid temperature influence the success of your reaction. For more information on selecting these parameters, see “Sample Volume and Lid Temperature” on page 31.

TIP: The value entered in the **Sample Volume** field determines the temperature control mode. If a sample value greater than 0 (zero) is entered, the instrument uses **Calculated Mode** to calculate the target temperature. If 0 (zero) is entered in the Sample Volume field, the **Block Mode** is used, in which case the thermal cycler assumes that the temperature of the sample is the same as that of the block.

In Figure 57, the run parameters include the user **EVA**, the sample volume, and lid temperature of 85°C. (Press **RUN** to bypass these fields and run the protocol without entering parameters or Sample ID).

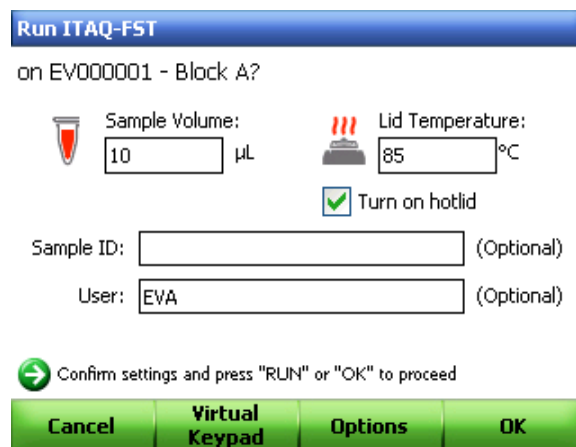

Figure 57. The run parameters of the ITAQ-FST protocol.

- (optional) To run a protocol on the C1000 thermal cycler at the same ramp speed as the iCycler® or DNA Engine® thermal cycler, select **Options**.

Then select **Enable emulation mode** and specify the desired thermal cycler. To send an email notification upon run completion, check the **Send email notification** box (Figure 58).

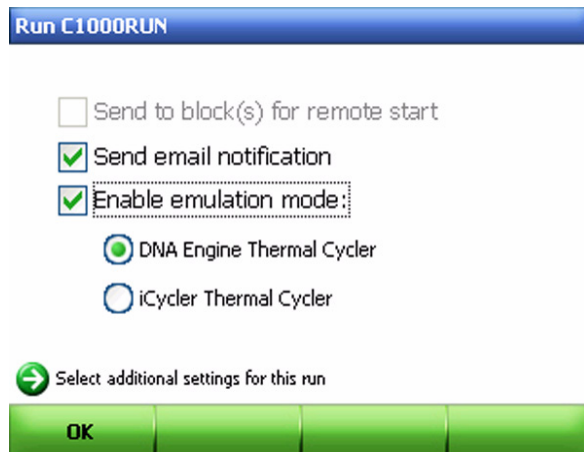

Figure 58. Set up the protocol to run in DNA engine emulation mode and send an email notification upon run completion.

- Start the run by selecting **OK**.

Monitoring a Run

During a run, the **VIEW** and **STATUS** keys provide quick ways to monitor all blocks:

- **STATUS** — shows the status of runs on multiple blocks
- **VIEW** — shows the time remaining on one block

To see the detailed run status for a particular cyclers reaction module:

1. Press **STATUS** to open the **System Status** screen. Toggle by pressing **VIEW** to view the list of connected cyclers and their reaction module blocks listed by cycler serial number/ name or protocol name.
2. Navigate to highlight the block of interest using the arrow keys, and press **STATUS**.
3. For an actively running block, press **VIEW** to switch between graphical status (Figure 59) and time remaining (Figure 60) screens.

Press **STATUS** to return to the System Status screen.

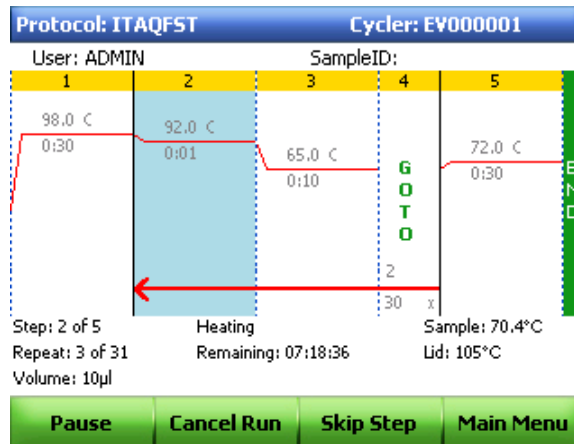

Figure 59. Switch back to the System Status screen by pressing STATUS.

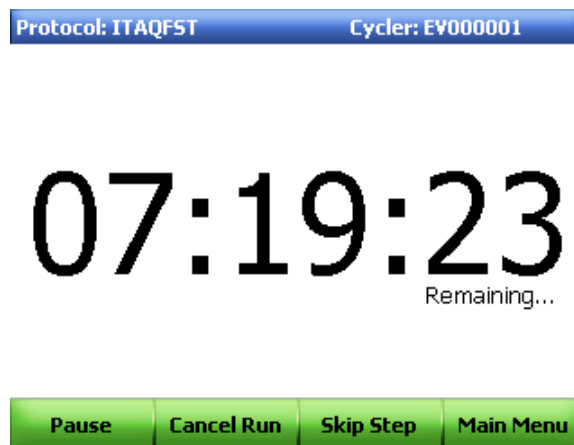

Figure 60. Protocol time remaining screen.

Pausing and Resuming a Run

A running protocol may be temporarily paused from the protocol status screen. During a pause, the thermal cycler continues heating or cooling to the target temperature, while the lid temperature is maintained.

TIP: After a power failure, the C1000 thermal cycler automatically resumes running a protocol, but also displays a warning message.

To pause and then resume a running protocol, follow these steps:

1. Press **Pause** from the graphical display showing the running protocol.

WARNING! Pausing a step can adversely change the outcome of the PCR reaction. If the protocol is paused during a temperature step, the PCR reaction stays at the target temperature for a longer hold time than the protocol step requires.

In Figure 61, the protocol is paused at step 3.

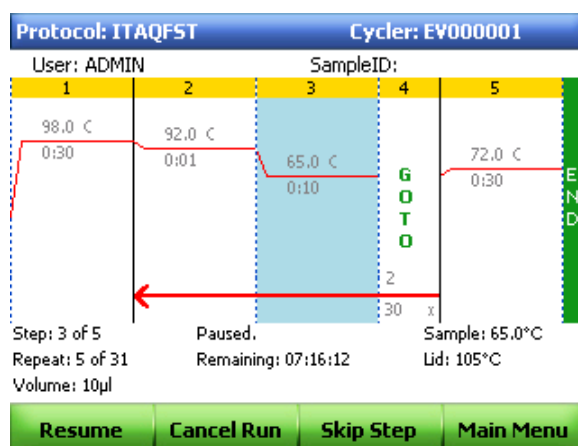

Figure 61. The running protocol is paused at step 3.

- To resume the protocol, select **Resume**.

Skipping Steps in a Protocol

Skip a step if it is necessary to shorten a protocol while it is still running. By repeatedly skipping steps, it is possible to bypass several GOTO loops and shorten a protocol.

To skip the current protocol step in the protocol status screen, follow these steps:

- View the current step.

In Figure 62, step 2 is currently running, and the last GOTO repeat in the protocol is running.

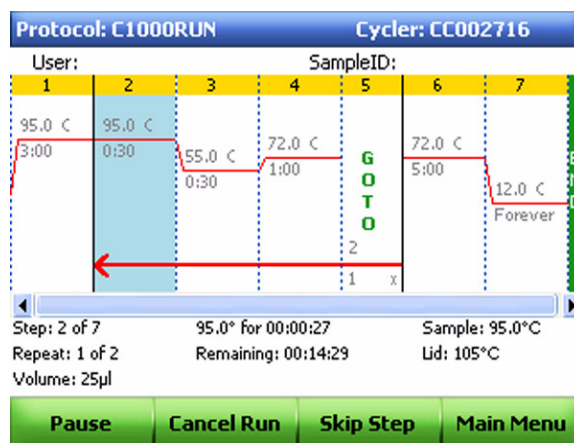

Figure 62. Select the step to be skipped.

- Select **Skip Step (F3)** to bypass the current step.

Press **F3** multiple times to skip more than one step. In Figure 63, **Skip Step** was selected 3 times, skipping steps 2, 3 and 4 in the last GOTO loop. Therefore, the C1000 thermal cycler finished the GOTO repeats, and is running in step 6.

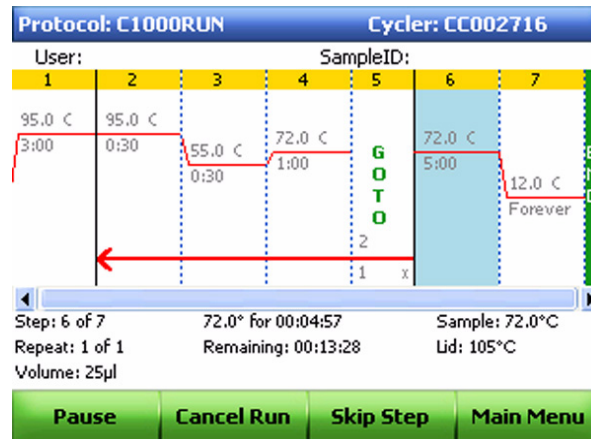

Figure 63. Press Skip Step to bypass a step.

Canceling a Run

A protocol may be cancelled while it is running. When the protocol is cancelled, the block immediately stops changing temperature.

NOTE: Do not turn the thermal cycler off immediately after cancelling a run. The fans might need to run in order to cool the block.

To cancel a protocol running on a single block:

1. Open the protocol status screen (Figure 64).

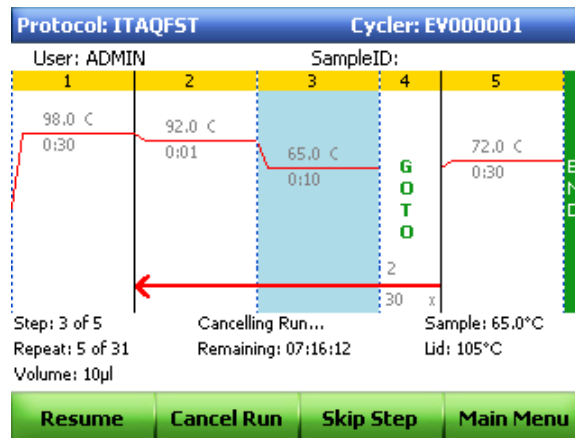

Figure 64. The protocol screen shows one block running.

2. Select **Cancel Run** to stop a single block (Figure 65).

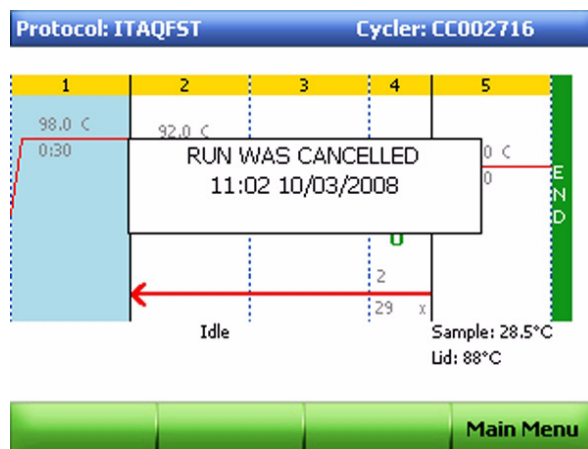

Figure 65. The protocol status screen is open and the run is cancelled.

To cancel a protocol running on multiple blocks:

1. Select the blocks in the System Status screen (Figure 66).

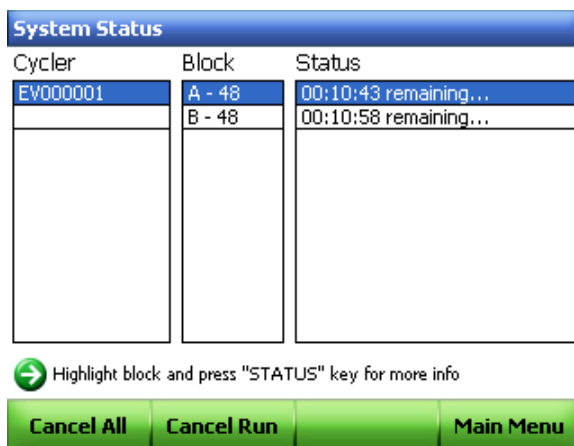

Figure 66. The System Status screen showing multiple blocks running.

- Select **Cancel Run** to cancel one block, or **Cancel All** to cancel the run on multiple blocks (Figure 67).

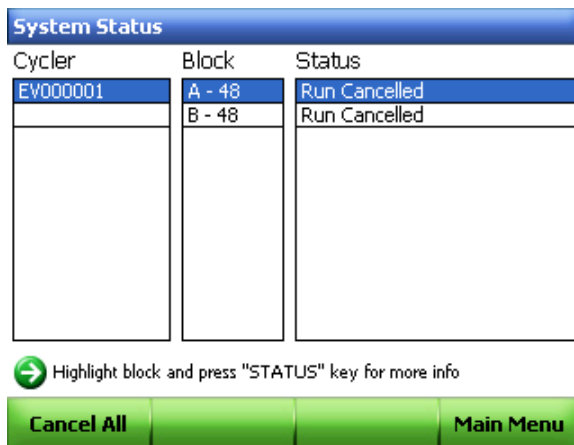

Figure 67. The System Status screen shows multiple cancelled runs.

Incubating Samples

You may keep samples at a constant temperature for any amount of time. The incubation continues indefinitely unless cancelled.

WARNING! Incubating samples for extended periods of time at 4–10°C, particularly in areas of high humidity, can cause excessive moisture condensation around the block.

To start incubating samples at a single temperature:

- Load samples and press **INCUBATE (0)**.

The **Instant Incubate** screen opens (Figure 68).

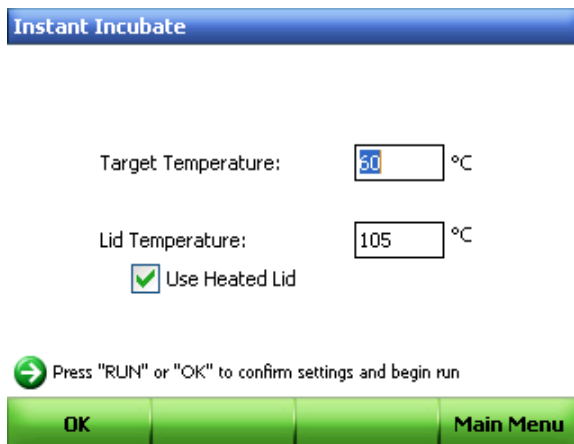

Figure 68. The Instant Incubate screen.

TIP: Set the default incubation temperature in the **Utilities Menu** (page 83).

NOTE: When incubation is occurring at temperatures below **Cutoff**, the lid will maintain a temperature of 31°C to prevent excessive condensation. The **Cutoff**

may be changed by the Administrator from the **Utilities Menu** by selecting **Utilities > Administrator Settings > Incubate Settings**.

2. Enter the **Target Temperature** and **Lid Temperature** parameters as needed.

3. Press **OK (F1)** twice to start the incubation (Figure 69).

NOTE: If multiple blocks are connected, the user can select the appropriate blocks to run the incubation]

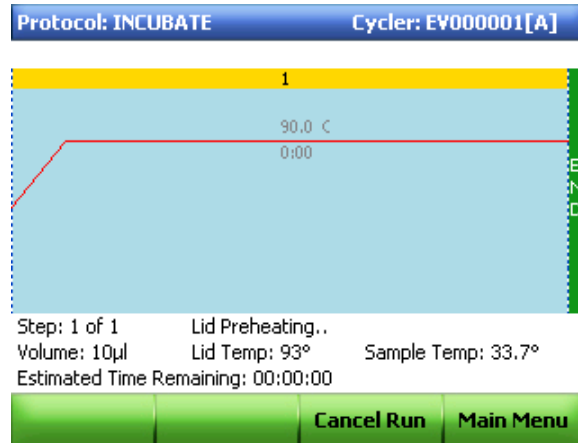

Figure 69. Start the incubation.

4. To end the incubation and view the final cancelled screen (Figure 70), select **Cancel Run**.

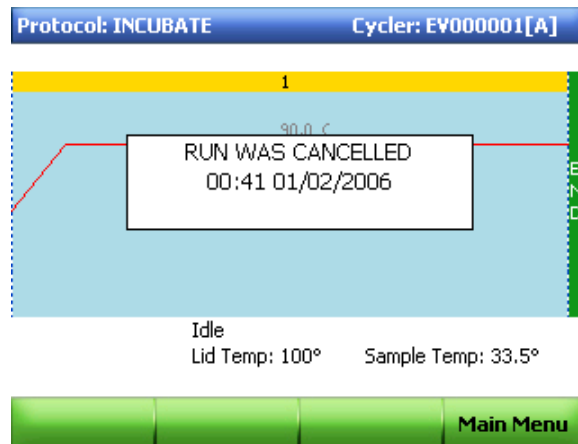

Figure 70. View the cancelled screen.

4 Protocol AutoWriter

Read this chapter for information on using the Protocol AutoWriter.

- Overview of the Protocol AutoWriter (below)
- The T_a calculator (page 46)
- Creating a protocol with the Protocol AutoWriter (page 48)

Overview of the Protocol AutoWriter

The Protocol AutoWriter uses standard PCR guidelines that automatically generate cycling protocols with initial template denaturation and enzyme activation, followed by cycles of denaturation, annealing and extension, then final extension steps. Protocols are based on user input parameters of target amplicon length, enzyme type and annealing temperature or primer sequences.

Protocols generated by the Protocol AutoWriter at various speed settings (**standard**, **fast** and **ultrafast**) may result in different product yields, because the software may adjust the annealing temperature, reduce the total number of protocol steps or GOTO repeats, shorten hold times, or reduce the temperature differentials between steps to generate these protocols.

The Protocol AutoWriter uses established PCR standards that reference data tables to produce the final suggested protocols. All protocols are either a standard two-step or three-step with a final extension step.

The steps and range of values generated by the Protocol AutoWriter are as follows:

1. **Initial hot start activation/denaturation step** — this step should be 95–98°C for 30 or 180 sec, depending on the enzyme type and speed setting used.
2. **Denaturation step** — this step should be either 95 or 98°C for 5–30 sec, depending on the enzyme type and speed setting used.
3. **Annealing step** — for this step, the Protocol AutoWriter uses either the primer annealing temperature (T_a) at **standard** speed that is calculated by the T_a calculator or a value that has been entered by the user.
 - **Length of annealing time** — this range is 10–30 sec depending on the speed setting. Two-step protocols combine annealing and extension steps
 - **The annealing temperature (T_a)** — this temperature is calculated based on primer characteristics and selected reaction speed. If the iProof enzyme is selected, 3°C are added to the T_a value

4. **Extension step (for 3-step protocols only)** — all extension steps are performed at 72°C with the duration based on calculating the times from set times per kbp (for example, 60 sec/kbp) of the largest amplicon in a size bin, often with some modifications at the smaller amplicon sizes.
5. **Number of repeats** — the steps are repeated 25–40 times depending on the speed selected.
6. **Final extension step** — this step is performed at 72°C for 1–5 min depending on speed settings.

The Protocol AutoWriter uses information about the reaction to automatically write a protocol. This feature enables the user to enter the following information about the PCR experiment:

- **Primers** — enter the reaction T_a for the primers being used. If the T_a is not known, enter the primer sequence in the T_a calculator so that the Protocol AutoWriter calculates this value
NOTE: The T_a is adjusted from the primer melting temperature (T_m) information that is based on the selected enzyme and the protocol speed selected.
- **Amplicon length** — enter the expected length of the PCR product
- **Enzyme type** — enter the DNA polymerase enzyme (**iTaq**, **iProof**, or **Other**)
If an enzyme other than iTaq™ or iProof™ DNA polymerase is being used, enter additional information including the hot-start activation time and the final extension time
- **Desired run speed** — select a reaction speed (**standard**, **fast**, or **ultrafast**). The Protocol AutoWriter optimizes the protocol depending on the selected speed setting.

The total run time is determined by the number of steps and cycles, the incubation time at each step, and the time it takes to reach uniformity at the target temperature.

To reduce the overall run time, the Protocol AutoWriter reduces one or more of the following:

- The total number of protocol steps (for primers with high T_m values, the annealing and extension steps can be combined into one step)
- The number of cycles
- The hold time in each temperature step
- The ramp time between steps by reducing the temperature change from one step to the next

For example, the Protocol AutoWriter may shorten a protocol by:

- Changing the initial template denaturation and enzyme activation step from 95°C for 3 min to 98°C for 30 sec hold time in each temperature step
- Changing the denaturation step in each cycle from 95°C for 30 sec to 92°C for 1 sec
- Combining the annealing and extension steps into a single step at 70°C for 20 sec

The T_a Calculator

The T_a calculator calculates the T_m value for each primer as well as the T_a value for the protocol at **standard** speed.

The T_a for the protocol is based on the average primer T_m values with the following applied:

- If the difference between the primer T_m values is $> 4^\circ\text{C}$, the $T_a = (\text{lower of the two primer } T_m \text{ values} + 2) - 4^\circ\text{C}$

- If the difference between the T_m values is $< \text{ or } = 4^\circ\text{C}$, the T_a = (average of the primer T_m values) $- 4^\circ\text{C}$

For each primer, the T_a calculator uses the base pair counting method for sequences of 14 pairs or less.

$$T_m = ((w \cdot A + x \cdot T) \cdot 2) + ((y \cdot G + z \cdot C) \cdot 4)$$

where **w**, **x**, **y**, and **z** are the number of the bases **A**, **T**, **G**, and **C** in the sequence, respectively.

For sequences longer than 14 bp, the nearest neighbor method is used:

In the nearest neighbor method, the melting temperature calculations are based on the thermodynamic relationship between entropy (order or a measure of the randomness of the oligonucleotide), enthalpy (heat released or absorbed by the oligonucleotide), free energy and temperature, where:

$$\Delta H = \Delta G + T \cdot \Delta S \text{ where}$$

ΔH = Enthalpy value, Cal/Mole*K

T = temperature, Kelvin.

ΔS = Entropy value, Cal/Mole*K

ΔG = Gibbs free energy in Cal/Mole*K

The change in entropy and enthalpy is directly calculated by summing the values for nucleotide pairs obtained by Breslauer et al. (1986).

The relationship between the free energy and the concentration of reactants and products at equilibrium is given by:

$$\Delta G = R \cdot T \cdot \ln \left(\frac{\text{DNA} \cdot \text{Primer}}{\text{DNA} + \text{Primer}} \right)$$

where R is the Gas Constant (1.986 Cal/Mole*K)

Substituting G in the two equations and solving for T gives

$$T = \frac{\Delta H}{\Delta S + R \cdot \ln \left(\frac{\text{DNA} \cdot \text{Primer}}{\text{DNA} + \text{Primer}} \right)}$$

Assumes the concentration of DNA and the concentration of the DNA-primer complex are equal.

It has been determined empirically that there is a 5 kcal free energy (3.4 kcal by Sugimoto et al. (1996) change during the transition from single stranded to B-form DNA.

This is presumably a helix initiation energy. Finally, adding an adjustment for salt gives the equation that the T_a calculator uses:

$$T = \frac{(\Delta H - 5(\text{KCal/K} \cdot \text{Mole}))}{\Delta S + (R \cdot \ln(1 / (\text{primer})))} + 16.6 \log_{10}(\text{SaltMolarity})$$

No adjustment constant for salt concentration is needed, since the various parameters were determined at 1 M NaCl, and the \log_{10} of 1 is zero.

The thermodynamic calculations assume that the annealing occurs at pH 7.0. The T_m calculations assume that the sequences are not symmetric and contain at least one **G** or **C**.

The oligonucleotide sequence should be at least 14 bases long to give reasonable T_m values. Less than 14 bases uses the base pair counting method (Figure 71).

INTERACTION		delta(H)	delta(S)	delta(G)
AA	TT	9.1	24	1.9
AT	TA	8.6	23.9	1.5
AC	TG	6.5	17.3	1.3
AG	TC	7.8	20.8	1.6
TA	AT	6	16.9	0.9
TT	AA	9.1	24	1.9
TC	AG	5.6	13.5	1.6
TG	AC	5.8	12.9	1.9
CA	GT	5.8	12.9	1.9
CT	GA	7.8	20.8	1.6
CC	GG	11	26.6	3.1
CG	GC	11.9	27.8	3.6
GA	CT	5.6	13.5	1.6
GT	CA	6.5	17.3	1.3
GC	CG	11.1	26.7	3.1
GG	CC	11	26.6	3.1

Figure 71. Breslauer interaction constants.

Creating a Protocol with the Protocol AutoWriter

Follow these steps to use the Protocol AutoWriter software for creating a new protocol:

1. Press the Protocol AutoWriter key to launch the software.

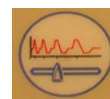

2. Enter the amplicon length in base pairs (bp) **Amplicon Length** box and the T_a in $^{\circ}\text{C}$ in the **Annealing Temperature** box. In Figure 72, the amplicon length is 494 bp and the T_a is 52°C . If the T_a is unknown, refer to “Creating a Protocol when the T_a is Not Known” on page 51.
3. Select the enzyme to be used for the reaction.

The default selection for the polymerase is **iTaq**. If iProof DNA polymerase is used, press the down arrow key to select **iProof**.

Protocol AutoWriter
Enter Target Values / Enzyme (Required):

Amplicon Length bp

Annealing Temperature¹ °C

iTaq
 iProof
 Other

¹ Enter Annealing temperature or use the Ta Calculator. The Annealing Temperature will be automatically adjusted based on enzyme and speed selections.

iProof enzyme adds +3°C to Annealing Temp

Ta Calc Next Main Menu

Figure 72. Enter the amplicon length, annealing temperature, and enzyme to be used.

NOTE: If **iProof** is selected, the protocol automatically adds 3°C to the T_a value. If **Other** is selected, additional options are presented, such as **Hot Start Activation** (Figure 73).

Protocol AutoWriter
Enter Target Values / Enzyme (Required):

Amplicon Length bp

Annealing Temperature¹ °C

iTaq
 iProof
 Other

Additional Parameters (Optional):

Temp Gradient Range °C

Hot Start Activation s

Final Extension s

Enter required values and any desired optional values

Ta Calc Next Main Menu

Figure 73. If “Other” is selected for the enzyme, additional options are presented.

4. Select **NEXT** to go to the reaction speed screen (Figure 74).
5. Use the right and left arrow keys to select the desired reaction speed on the slider bar.
Note the change in the annealing temperature and in the estimated total run time as the speed is changed. The annealing temperature used in the program will be 4°C below the primer average T_m for the standard speed and 2°C below the primer T_m average for fast speed. The unadjusted primer T_m average will be used for the ultrafast speed. These

times are displayed on this speed selection screen as well as on later program display screens.

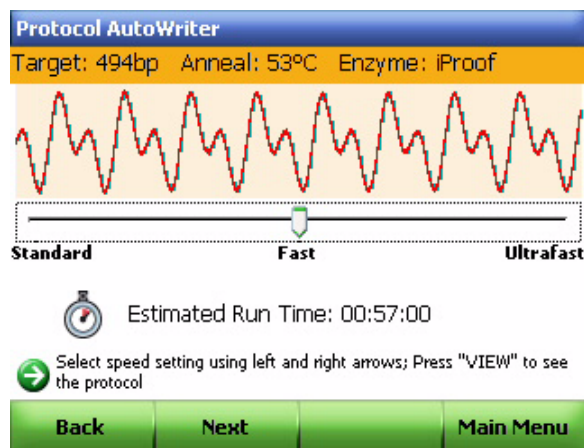

Figure 74. The amplicon length, enzyme, and T_a are listed across the top of the reaction speed screen.

6. Select **Next**.
7. Review the new protocol in the graphical format.
Press **VIEW** to display the program in a textual format. All aspects of the program can be edited from either the textual or graphical format by navigating to the desired step with the arrow keys then using the various action keys.
To edit the protocol, see “Creating, Editing, Naming, and Saving Protocols” on page 19.
8. Select **Done** to save the protocol, then press the arrow keys to select the folder where you want to save the protocol.
 - To **collapse** a folder, press the **left** arrow key
 - To **expand** a folder, press the **right** arrow key
 - To **create** new folder, press **Create Folder**
9. Select **Save** to store the new protocol in the selected folder.
In Figure 75, the protocol is named **FST2** and saved in the **GRANT** folder.

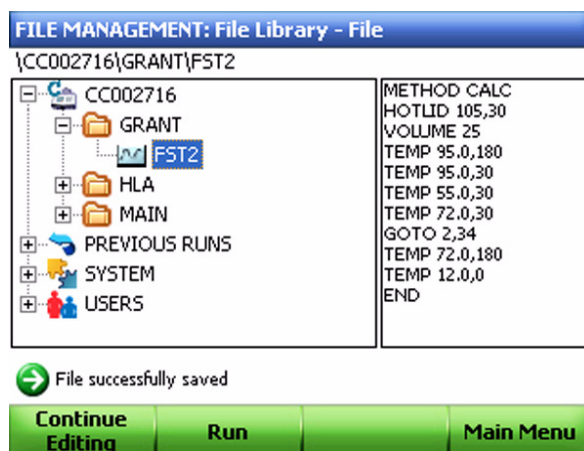

Figure 75. Save the protocol file in the appropriate folder.

10. Press **RUN** to run the protocol, or select **Main Menu** to return to the main menu.

NOTE: To make additional changes to this protocol, select **Continue Editing**.

Creating a Protocol when the T_a is Not Known

When the T_a is unknown, use the following instructions to create a protocol with the Protocol AutoWriter software.

1. Press the Protocol AutoWriter key to launch the software.

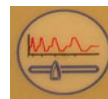

2. Press **T_a Calc (F1)** from the main Protocol AutoWriter screen.

3. Enter the primer sequences in the boxes using the four keys along the left side of the screen corresponding to **A**, **T**, **G** and **C**. In Figure 76, the primers are:

- **Forward primer:** CTG GAG CCT TCA GTT GCA G
- **Reverse primer:** GAA GAT GGT GAT GGG ATT TC

To correct a wrong base entry, press **BACK** or **Backspace (F3)** and erase the base immediately to the left of the cursor. If necessary, use the left and right arrow keys to position the cursor within the primer sequence. **RESET** clears the entire sequence.

The screenshot shows the 'Protocol AutoWriter' software interface. It features a blue header bar with the text 'Protocol AutoWriter'. Below the header, there are two input fields for primer sequences. The first field is labeled 'Forward Primer' and has a '5'' label to its left. The second field is labeled 'Reverse Primer' and also has a '5'' label to its left. To the left of each input field is a circular icon containing a letter: 'A' for the forward primer and 'T' for the reverse primer. Below the input fields, there are two rows of information. The first row is labeled 'Forward Tm:' and shows a value of 'Average of primer Tm's' with a degree Celsius symbol on either side. The second row is labeled 'Reverse Tm:' and shows a value of 'Ta at Standard Speed(iTaq)' with a degree Celsius symbol on either side. Below these rows, there is a green arrow icon and the text 'Enter desired values'. At the bottom of the screen, there are four green buttons: 'Reset', 'Calculate', 'Backspace', and 'OK'.

Figure 76. Enter primer sequences.

4. Once the primer sequences have been entered, select **Calculate**.

The Protocol AutoWriter calculates and displays the T_m of each primer and the average T_m and T_a values (Figure 77).

The screenshot shows the Protocol AutoWriter interface with the following data:

Primer Type	Sequence (5')	Forward T_m (°C)	Reverse T_m (°C)	Average of primer T_m 's (°C)	T_a at Standard Speed (iTaQ) (°C)
Forward	CTG GAG CCT TCA GTT GCA G	59.7		58.3	
Reverse	GAA GAT GGT GAT GGG AAT TC		56.9		54.3

Buttons: Enter desired values, Reset, Calculate, Backspace, OK

Figure 77. The T_m of each primer and the average T_m and T_a values are calculated by the Protocol AutoWriter software.

NOTE: If the primer T_m values are greater than 4°C apart, the Protocol AutoWriter uses the lower primer T_m value + 2°C as a basis for calculating the T_a value, which can be further modified by the enzyme and reaction speed selections.

NOTE: The T_a calculator generates an annealing temperature for standard speed with iTaq DNA polymerase. When using a different enzyme, the speed settings automatically adjust the T_a .

5. Select **OK** to return to the main Protocol AutoWriter screen.
6. Follow steps 6–10 in “Creating a Protocol with the Protocol AutoWriter” on page 48 to make necessary changes and then save the protocol.

5 Managing Protocol Files and Folders

Read this chapter for information on managing protocol files and folders.

- Contents of a protocol file (below)
- Managing protocol files and folders (page 54)

Contents of a Protocol File

A PCR protocol is based on temperature steps, where the sample is kept at a target temperature for a specific amount of time (called the hold time). A PCR protocol also includes a cycle, where temperature steps repeat many times. A gradient temperature step is a specialized step that includes a temperature gradient across the block.

In general, a PCR protocol includes the following steps:

1. **An initial temperature step** — this step denatures the template and may also activate the polymerase. To add an initial step in the protocol file, add a temperature step (see “Changing Target Temperature and Hold Time” on page 22 for details).
2. **A cycle of steps to amplify the PCR product** — this set of temperature steps repeats in a cycle and amplifies the PCR product. Typically the cycle includes three temperature steps called denaturing, annealing, and extension steps. These steps denature the DNA template, anneal the primer to the template, and allow the polymerase to extend the complementary strand of DNA. However, under certain conditions the annealing and extension steps combine in a shorter two-step cycle.
To add the denaturing, annealing, or extension steps in the protocol file, add a temperature step (see “Inserting a Protocol Step” on page 22) or a gradient step (see “Adding or Removing a Temperature Gradient” on page 24). To cycle these temperature steps, add a GOTO step immediately after the last step that you want to cycle (see “Changing Parameters in a GOTO Step” on page 29).
3. **A final extension step** — the final extension temperature step serves to finish extending any PCR product that did not fully elongate during cycling.
To add a final extension step in the protocol file, add a temperature step.

The protocol step on the C1000 thermal cycler varies from the typical PCR protocol steps. When a typical PCR protocol is transferred to the C1000 thermal cycler, the steps can be translated into the following types of protocols:

- **Temperature** — the same temperature as a typical PCR protocol step
- **Gradient** — a temperature step that includes a thermal gradient
- **GOTO** — used to add loops and create a cycle in PCR

See “Changing Target Temperature and Hold Time” on page 22 for details on modifying the temperature parameters.

Options for Temperature and Gradient Steps

Each temperature or gradient step in the C1000 thermal cycler can include additional parameters. For details on modifying any of the parameters, see the following sections:

- “Adding or Removing a Temperature Increment” on page 26
- “Adding or Removing an Extend Time” on page 27
- “Adding or Removing a Beep” on page 28
- “Changing Parameters in a GOTO Step” on page 29

Managing Protocol Files and Folders

To manage protocol files and folders, select **Files** from the main menu to open the file library. The menu of functions in the file library provides options for managing files and folders and changes based on what is selected in the file library. Table 10 lists all the functions in the **Files** option. File names can have a maximum of 8 characters.

Table 10. List of functions in the Files option

Function	Description
Folders	
Create Folder	Creates a new folder in the C1000 thermal cycler, an attached S1000 thermal cycler, or a USB key
Copy All	Copies all files from one destination to another existing protocol folder or USB key
Copy/Move Folder	Copies or moves an existing folder to another cycler or USB key
Delete Folder	Deletes the folder and all of its contents
Rename Folder	Renames a folder
Protocols	
Copy/Move Protocols	Copies or moves an existing protocol to another folder location
Delete Protocols	Deletes a protocol
Rename Protocols	Renames a protocol
Rename Cycler	
Rename Cycler	Renames the thermal cycler
Main Menu	Returns to the main menu

Creating a New Folder

To create a new folder:

1. Select **Files** from the main menu.
2. Select a thermal cycler or USB key from the main menu.

In Figure 78, the new folder is to be created under a C1000 thermal cycler called **LUCY**.

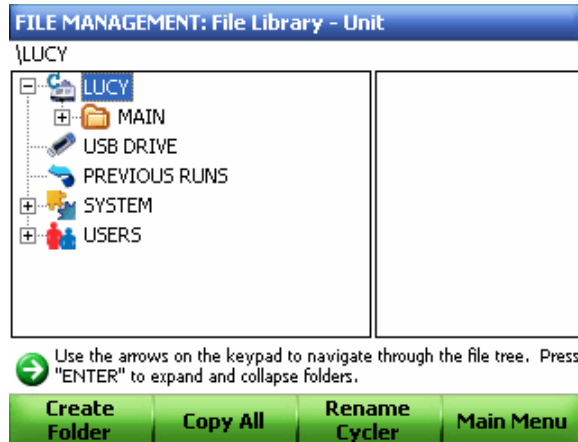

Figure 78. Select the thermal cycler or USB key where the folder is to be created.

3. Select **Create Folder** and enter a folder name in the text box. Then select **OK**.
The name of the newly created folder is **AVA** (Figure 79).

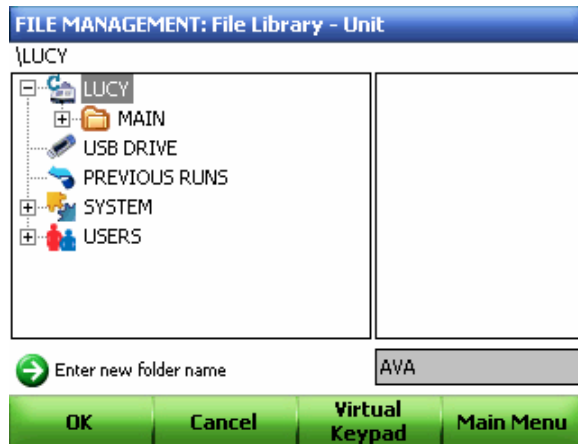

Figure 79. Enter the new protocol name in the text box.

4. Confirm that the folder was successfully created (Figure 80).

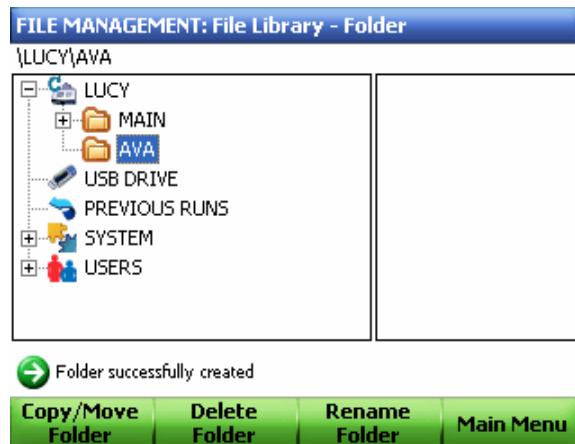

Figure 80. The newly created folder AVA appears under the LUCY thermal cyclers.

Copying All Files

To copy all files from one destination to another folder or USB key:

1. Select **Files** from the main menu.
2. Select the cyclers or USB key from which files are to be copied (Figure 81).

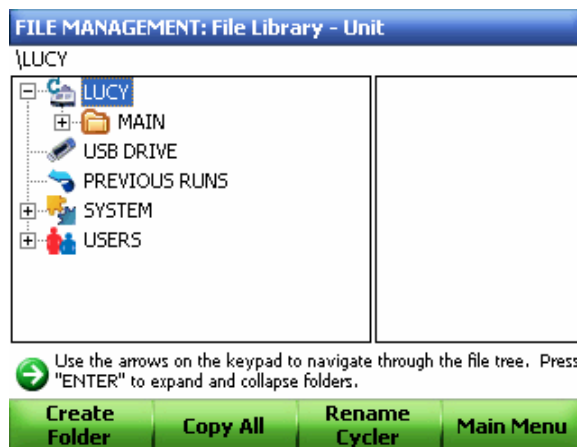

Figure 81. Select the LUCY thermal cyclers.

3. Select **Copy All**.
4. Destination choices appear in the right side window as shown in Figure 82.

- Using the up and down arrows, select the destination to copy all contents.

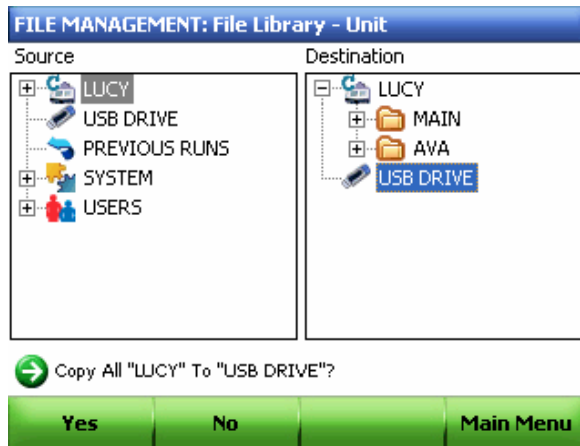

Figure 82. Select the destination folder where all files are going to be copied.

- Select **Yes** to confirm that all files were successfully copied (Figure 83).

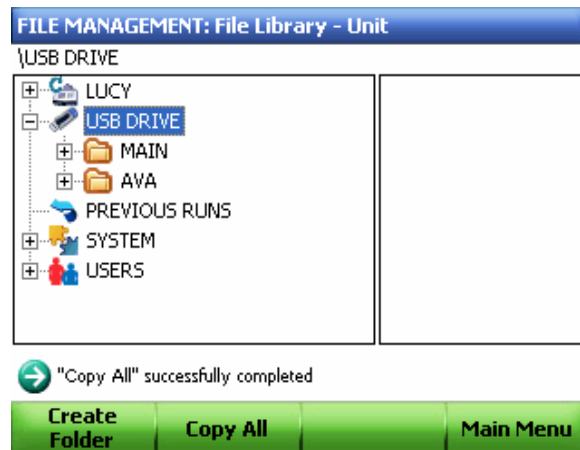

Figure 83. All files from the LUCY thermal cycler are copied into the USB key.

Copying/Moving a Folder

NOTE: The **MAIN** folder cannot be moved.

To copy or move a folder to an existing folder:

- Select **Files** from the main menu.
- Use the up and down arrow keys to select the folder to be copied or moved.
- Select **Copy/Move Folder**.
- Option to **Copy Folder** or **Move Folder** appears. Select the appropriate option.

- Using the up and down arrow keys, select new destination for the folder as shown in Figure 84.

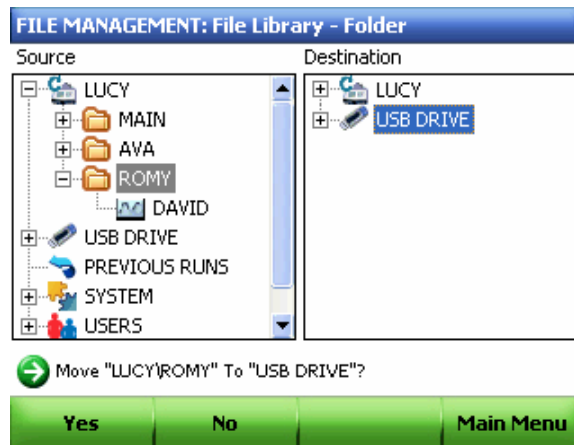

Figure 84. The source and destination folders are highlighted in this example.

- Select **Yes** to confirm that the folder was successfully moved (Figure 85).

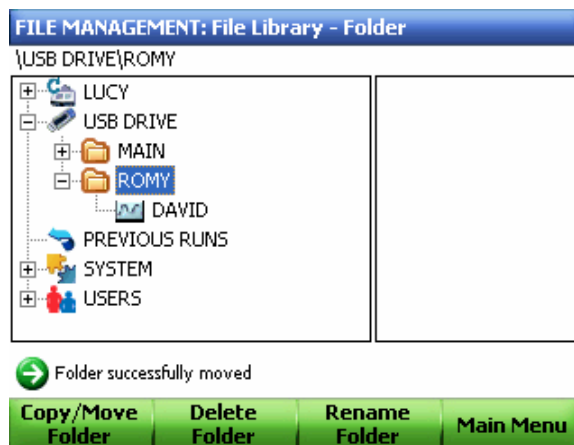

Figure 85. The ROMY folder is moved into the USB key.

Deleting a Folder

NOTE: The **Main** folder cannot be deleted.

To delete a folder and all of its contents:

- Select **Files** from the main menu.
- Using the up and down arrow keys, select the folder to be deleted.
- Select **Delete Folder**.
- Select **Yes** to confirm.

Renaming a Folder

To rename a folder:

1. Select **Files** from the main menu.
2. Using the up and down arrow keys, select the folder to be renamed.
3. Select **Rename Folder** (Figure 86).

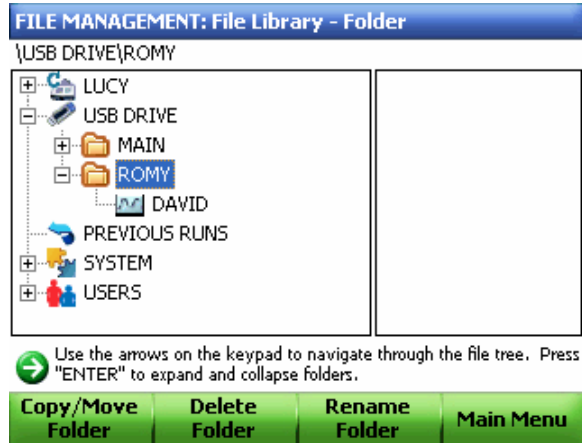

Figure 86. Select the folder to be renamed.

4. Enter a new folder name in the text box.

NOTE: The **Main** folder cannot be renamed (Figure 87).

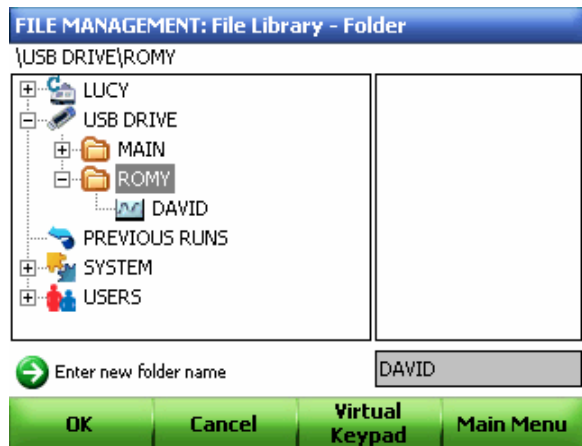

Figure 87. The new folder name is entered in the text box.

5. Select **OK** and confirm that the folder was successfully renamed (Figure 88).

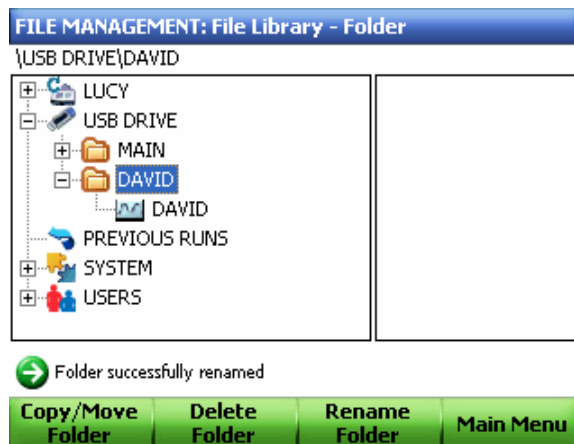

Figure 88. The folder was successfully renamed.

Copying/Moving a Protocol

NOTE: When copying or moving protocols into a USB key, the protocols must be placed in a folder within the USB key. Protocols cannot be copied directly to the root directory.

To copy or move a protocol:

1. Select **Files** from the main menu.
2. Use the up and down arrow keys to select the protocol to be copied or moved (Figure 89).

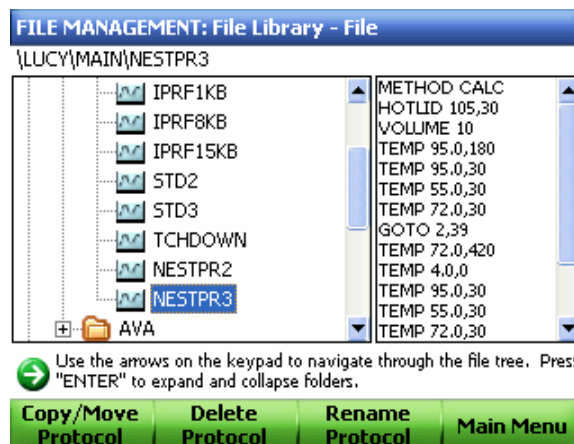

Figure 89. Select the protocol to be copied.

3. Select **Copy/Move Protocol**.
4. Option to **Copy Protocol** or **Move Protocol** appears. Select the appropriate option.

- Using the up and down arrow keys, select the destination folder (Figure 90).

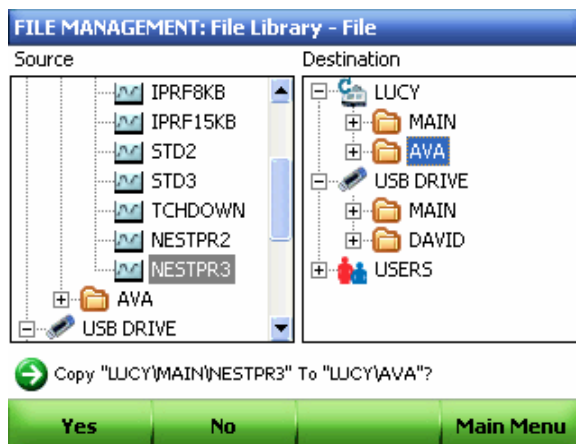

Figure 90. Select the destination folder.

- Select **Yes** to confirm that the protocol was successfully copied (Figure 91).

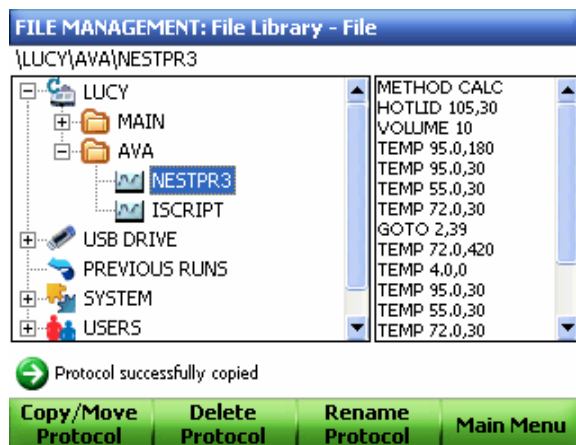

Figure 91. The protocol was successfully copied.

Deleting a Protocol

To delete a protocol:

- Select **Files** from the main menu.
- Use the up and down arrow keys to select the protocol to be deleted.
- Select **Delete Protocol**.
- Select **Yes** to confirm.

Renaming a Protocol

To rename a protocol:

- Select **Files** from the main menu.
- Use the up and down arrow keys to select the protocol to be renamed.

3. Select **Rename Protocol**.
4. Enter a new name in the text box and select **OK**.

6 Optimizing PCR on the C1000 Thermal Cycler

Read this chapter for information on optimizing PCR.

- Optimizing a protocol for faster PCR (below)
- Optimizing annealing temperature step with a gradient (page 65)
- Optimizing PCR with small sample volumes (page 66)
- Transferring protocols from another thermal cycler (page 66)
- Troubleshooting PCR problems (page 66)
- Selecting compatible reaction vessels and sealing options (page 67)

Optimizing a Protocol for Faster PCR

Optimizing a protocol for faster PCR can reduce the total run time by one-third. In contrast, running the same protocol on a thermal cycler with a faster ramp rate only cuts minutes from the total run time. Optimizing the protocol for speed can also result in better PCR results.

TIP: Use the Protocol AutoWriter software to automatically create a protocol that is optimized for speed (page 48).

Complete optimization of a protocol involves selecting the appropriate reagents, enzymes, and primers, as well as testing the parameters of the PCR protocol. For more detailed information on optimizing protocols for fast PCR, refer to the following resources:

- **Gene Expression Gateway (www.bio-rad.com/genomics/)**. Go to the web site and select *Application | Techniques > Quantification > Fast PCR*
- **BioRadiations Magazine volume 118** in PDF. Go to discover.bio-rad.com and search the *Literature* for “Fast PCR”. This magazine includes articles on tips for optimizing the reagents

To optimize a protocol for fast PCR using the C1000 thermal cycler, follow these guidelines:

- **Shorten the denaturing step during cycling**

The initial denaturation step requires a longer hold time than denaturing steps during each subsequent cycle. This difference is due to the activation of polymerase and to the longer initial DNA template. Once the PCR target is amplified, the amplicons then serve as shorter templates that are easier to denature during cycling.

To shorten the denaturation step, enter a hold time of 1 sec for PCR products that are less than 500 bp. Then test this shorter hold time to verify that a 1 sec denaturation is

sufficient to produce amplicons. Alternatively, add an increment (see “Adding or Removing a Temperature Increment” on page 26) to the denaturation step to test for the best hold time.

- **Create a two-step protocol by combining annealing and extension into a single step**

Most polymerases remain active throughout the typical range of annealing temperatures (55–70°C). Reduce the total run time by creating a two-step protocol that combines the annealing and extension steps into a single step. A two-step protocol can produce a product that is similar to one produced by a three-step protocol for target sequences up to 200 bp.

To create a two-step protocol, keep the annealing temperature step and omit the extension step. Then adjust the hold time for the annealing step based on the length of the amplicon. Start with a hold time that is 10 sec per 100 bp of the target.

Alternatively, optimize the annealing temperature using a temperature gradient across the block, and pick the final annealing temperature from the best results of the gradient experiment. See “Optimizing Annealing Temperature Steps with a Gradient” (page 65) as an example. Optimization of the annealing step is critical because it determines the specificity of the reaction. If the annealing temperature is too high, the primers do not anneal easily, and if the annealing temperature is too low, the reaction will result in primer mismatches, lower PCR yield, and nonspecific amplification.

- **Optimize temperature steps to minimize the ramping time**

The larger the temperature difference between two successive steps in a protocol, the longer the time required to reach the next target temperature. Shorten the run time by minimizing the difference between target temperatures in successive steps.

To minimize target temperature differences, run a temperature gradient by adding a gradient (see “Adding or Removing a Temperature Gradient” on page 24). Begin by optimizing the difference between the annealing and extension temperatures. Use the results of this gradient experiment to determine the highest possible annealing temperature without sacrificing the PCR yield. See “Optimizing Annealing Temperature Steps with a Gradient” (page 65) as an example. Finally, choose an annealing temperature with the smallest temperature difference from the extension temperature.

- **Minimize the final extension step**

The final extension step completes the synthesis of amplicons. Optimize this step to obtain a high percentage of complete amplicons at the end of the PCR. During each cycle, the extension step is typically 30 sec. If amplification for 30 sec is sufficient during cycling, then a longer final extension step is unnecessary.

To minimize the final extension step, choose a hold time between 30 sec and 2 min for targets between 100 and 1,000 bp. Then test the hold time chosen for sufficient amplification. Alternatively, add an increment to the extension step to test for the best hold time.

- **Minimize the number of repeats in a GOTO step**

Minimize the repeats in the GOTO step to minimize the number of cycles in the protocol. Before adjusting the number of cycles, the approximate concentration of PCR template must be known.

To approximate the concentration of an unknown template, start with 30 to 45 cycles the first time you run the protocol. Then detect the PCR product in a gel stained with ethidium bromide and estimate the starting concentration. If the concentration is sufficient, shorten the number of cycles by 5 and then run the protocol again. Once the concentration of the target sequence is known, minimize the number of cycles in the

protocol until the concentration of the PCR product is too low. Choose the best number of GOTO loops from the results of these reactions.

Optimizing Annealing Temperature Steps with a Gradient

Optimizing the annealing step is critical for an efficient reaction that yields a clean product. Use a gradient to optimize the temperature of the annealing step. In addition, you can use a gradient step to optimize other temperature steps.

Follow these steps as a suggested approach to optimizing the annealing temperature:

1. Calculate the predicted annealing temperature based on the melting temperature (T_m) of the primers and template.

Use the T_a calculator of the C1000 thermal cycler to find the T_m of any combination of primers and template.

2. Create a PCR protocol with a gradient step in the annealing step.

Choose a gradient range that is as wide as possible to test for the optimal annealing temperature, and bracket the calculated T_a by 5–12°C. For example, if the calculated T_a is 55°C, then use a 24°C gradient to bracket that T_a .

NOTE: The widest possible gradient on the C1000 thermal cycler is 24°C.

3. Choose a high annealing temperature from the results of the gradient PCR run to reduce the chance of nonspecific primer binding. See step 2, above, for details on creating a gradient. In Figure 92, the gradient range is 53–78°C and the best annealing occurs at 68.5°C.

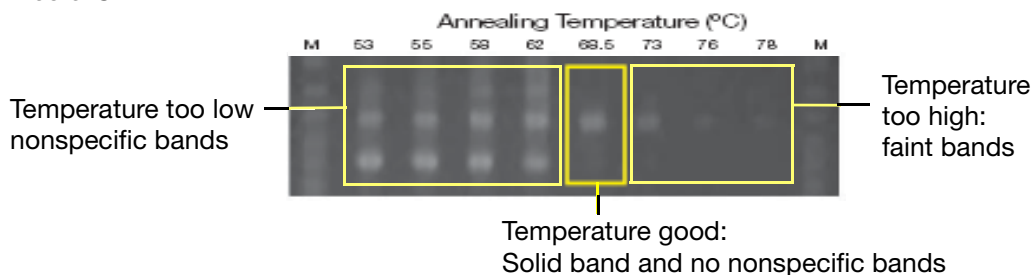

Figure 92. The effect on annealing temperature on the outcome of a PCR run.

As a starting point, use the highest annealing temperature and subtract 1 or 2°C. Do not use the absolute highest temperature. At higher temperatures, the yield decreases and results in faint bands. Furthermore, at high temperatures, the primers might behave inconsistently from one PCR run to another.

4. (Optional) Run a narrower annealing temperature gradient using the results from the first, wider temperature gradient. Bracket the annealing temperature chosen in step 3 (above) by 5°C. Choose the final annealing temperature from the highest successful temperature in the results of this gradient.

For example, if the highest successful annealing temperature in step 3 is 60°C, then bracket that temperature with a narrower gradient ($\pm 5^\circ\text{C}$). In this example, the narrow gradient is 55–65°C. Choose the final annealing temperature from a high successful temperature in the gradient experiment as described in step 3 above.

Optimizing PCR With Small Sample Volumes

Running a PCR protocol with a small sample volume requires optimization to prevent evaporation and condensation. Follow these suggestions for optimizing PCR with a reaction volume below 10 μ l:

- **Control evaporation with a wax seal**
A wax, such as Chill-out™ liquid wax, is the best seal for reducing evaporation. Further reduction is possible by using a second seal, such as a cap or film.
- **Reoptimize the annealing temperature to prevent nonspecific priming and increase target amplification**
When running an established protocol with a smaller sample volume (<10 μ l), the annealing temperature may need to be reoptimized. If mispriming or low amplification is observed (and reagent problems have been ruled out), adjust the protocol by optimizing the annealing temperature step using a gradient as described on page 65.
- **Lower the lid temperature to reduce sample loss due to evaporation**
The heated lid prevents condensation from forming in the microplate or tube, which is critical when the sample volume is small. However, using the same lid temperature with a smaller sample volume can increase evaporation. To prevent evaporation, lower the lid temperature and test the reaction for condensation.
- **Run the reaction in a 384-well reaction module**
The 384-well block is optimized for small sample volumes and is the best block for this application.

Transferring Protocols from Another Thermal Cycler

To achieve the same results after transferring a PCR protocol to the C1000 thermal cycler from another thermal cycler, the ramp rate may need to be lowered. If identical reactions that are run on a thermal cycler with a slower ramp rate provide the same data, change the ramp rate on the C1000 thermal cycler.

When transferring a protocol to the C1000 thermal cycler, follow these guidelines:

- Match the ramp rate of the other thermal cycler by changing the rate in each relevant step on the C1000 thermal cycler (see “Changing the Ramp Rate” on page 27). In general, the ramp rate for the annealing step could be lowered when a protocol from a thermal cycler with a slower ramp rate is moved to the C1000 thermal cycler
- Increase the amount of Mg⁺⁺ in the reagents to help the primers anneal when the conditions have changed. Adding Mg⁺⁺ increases the primary product, but may also cause some secondary PCR products
- Adjust the temperature in each step to reoptimize the protocol and the annealing temperature (see “Optimizing Annealing Temperature Steps with a Gradient” on page 65)

Troubleshooting PCR Problems

This section provides a quick guide for PCR troubleshooting options. For more detailed and extensive troubleshooting, go to the Gene Expression Gateway (www.bio-rad.com/genomics/) and select *Support > Amplification Central > PCR Doctor*

Use the following suggestions to adjust and reoptimize a reaction that has failed due to the presence of:

- **Nonspecific PCR products, in addition to the target product**

Nonspecific products result from mispriming. If reagent problems have been ruled out, increase the annealing temperature to increase specificity of primer binding. To find the optimal annealing temperature, use a gradient.

- **Nonspecific PCR products without the target product**

Nonspecific product with no target production is a result of complete mispriming. If reagent problems have been ruled out, adjust the hold time in the annealing and extension steps to increase specificity of primer binding. Increasing the hold time also provides more time for complete extension.

- **Low yield of the target PCR product**

Low PCR yield is a result of mispriming, an overly short extension hold time, or too high an annealing temperature. When the low yield is not a result of reagent problems, adjust the protocol.

Run a touchdown protocol (page 98) to increase amplification of the target product. Alternatively, decrease the annealing temperature or run a gradient to optimize the annealing temperature (see “Optimizing Annealing Temperature Steps with a Gradient” on page 65).

Selecting Compatible Reaction Vessels and Sealing Options

The composition and thickness of reaction vessels influence the outcome of a reaction. Microplates, tubes, sealers, and caps come in a variety of compositions and colors. Bio-Rad tests the standard supplies listed in Table 11 for compatibility with the 1000-series thermal cyclers.

For a full list of available reagents and supplies, refer to the Life Science Research Product catalog or online at discover.bio-rad.com. Whenever the source or composition of vessels is changed, it is good practice to reoptimize the protocol before running an important experiment.

NOTE: Sealing wax, such as Chill-out liquid wax, is specifically recommended to seal small sample volumes of less than 10 μ l. Wax solidifies at room temperature. Pierce the solid wax with a micropipet tip to remove the sample. For more information about optimizing protocols for small sample volumes, see “Optimizing PCR With Small Sample Volumes” on page 66.

Table 11. Microplates, tubes, and sealing options that are compatible with 1000-series thermal cyclers

TUBES AND MICROPLATES		CAPS AND SEALERS	
Description (Catalog Prefix*)	Volume and Number	Description (Catalog Prefix*)	
Tubes			Caps (TCS*)
Individual tubes with caps (TFI* and TWI*)	0.2 ml		(Included)
Strip tubes (TBS*)	0.2 ml, 8- and 12-tube		Strip
Strip tubes, low profile (TLS*)	0.2 ml, 8-tube		Strip
Microplates		Film (MS*)	Caps (TCS*)
Unskirted and full height (MLP*)	24-, 48-, and 96-well	A, B, F	Strip

Table 11. Microplates, tubes, and sealing options that are compatible with 1000-series thermal cyclers

TUBES AND MICROPLATES		CAPS AND SEALERS	
Unskirted and low profile (MLL*)	48- and 96-well	A, B, F, P	Strip
Skirted and full height (MSP*)	96- and 384-well	A, B, F	Strip
Skirted, full height, and hard-shell (HSP*)	96- and 384-well	A, B, F	Strip

* The prefix of the catalog number for each series of supplies.

7 The C1000 Manager Software

Read this chapter for information on using the C1000 Manager software.

- Computer requirements (below)
- Software installation (page 70)
- Controlling thermal cyclers using C1000 Manager software (page 71)
- Copying and running protocols from a USB key (page 78)
- User preferences (page 76)
- Managing users (page 78)

Computer Requirements

The C1000 Manager software is run on a PC computer on either the Windows XP or Windows Vista operating system. Table 12 lists the computer system requirements for the software on Windows XP and Windows Vista.

Table 12. Computer requirements for the C1000 Manager software.

System	Minimum	Recommended
Operating system	Windows XP Professional SP2 and above or Windows Vista Home Premium and above	Windows XP Professional SP2 and above or Windows Vista Home Premium and above
Drive	CD-ROM Drive	CD-RW Drive
Hard drive	10 GB	20 GB
Processor speed	1 GHz	2 GHz
RAM	1 GB RAM (2 GB for Vista)	2 GB RAM
Screen resolution	1024 x 768 with true-color mode	1280 x 1024 with true-color mode
USB	USB 2.0, Hi-Speed port	USB 2.0, Hi-Speed port
Operating system	Windows XP, with Service Pack 2	Windows XP, with Service Pack 2
Internet browser	Internet Explorer	Internet Explorer
Software		Microsoft Office Suite

Software Installation

The C1000 Manager software must be installed on the computer by a user with administrative privileges. To install the software, follow these instructions:

1. Log in to the PC as the Administrator.
2. Place the C1000 Manager software CD in the computer's CD drive.
3. The software launch page should appear automatically. Click **Install Software** on the software launch page (Figure 93).

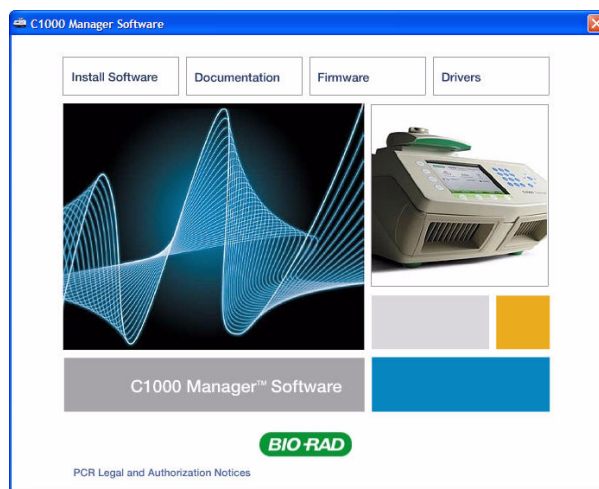

Figure 93. Software installation screen.

4. Follow the instruction on screen to complete installation. When completed, the Bio-Rad C1000 Manager software icon will appear on the desktop of the computer.
TIP: Select **Documentation** to find searchable PDF copies of the instrument manuals and other documentation.
5. If the launch page does not appear automatically, double-click on (CD drive):\Bio-Rad C1000.

Installing the Drivers

If the C1000 thermal cycler is going to be run in software-controlled mode, drivers must be installed on the computer. Use only the orderable USB cable (catalog #184-8000), which is sufficiently shielded to prevent data loss.

To install the system drivers:

1. Connect the C1000 thermal cycler chassis to the computer by plugging a USB cable into the USB B port located on the back of the chassis (see “The back panel of the C1000 thermal cycler includes data ports (Figure 2).” on page 2), and then connecting the cable into the USB A port located on the computer.
2. Turn on the C1000 thermal cycler using the power switch on the back of the chassis. Follow the instructions in the **Found New Hardware Wizard** that launches after the instrument is first detected by the computer.

3. In the first screen, select **Yes, this time only** to instruct Microsoft Windows to connect to **Windows Update** to search for software (Figure 94). Select **Next**.



Figure 94. Searching for the software.

4. Instruct the wizard to install the software automatically. Select **Next** to continue installing the drivers (Figure 95). Select **Finish** at the software installation completion screen when the drivers are installed.

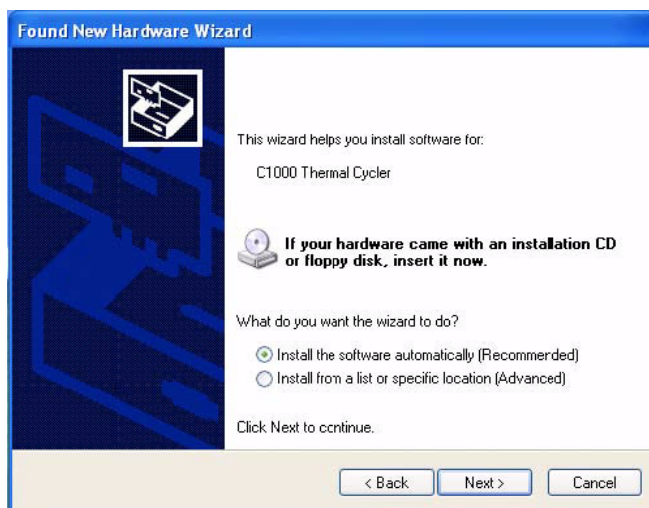

Figure 95. Driver Installation screen.

Controlling Thermal Cyclers Using C1000 Manager Software

C1000 Manager software controls up to 32, 1000-series cyclers at once from a single computer. Protocols can be run on individual or multiple blocks, either independently or simultaneously.

To open the software:

1. Double-click the Bio-Rad C1000 Manager icon on the desktop to open the C1000 Manager software on the PC.

Viewing Connected Instruments

All attached 1000-series thermal cyclers appear in the **Detected Instruments** panel on the left side of the screen. Click on the + and – symbols on the left side of each attached instrument in the **Detected Instruments** pane to expand or collapse the list of instruments. The list also shows individual blocks (**Block A** and **Block B**) for each dual 48/48 reaction module.

TIP: Right-click any instrument in the **Detected Instruments** pane to open the **Instrument Properties** window and rename the instrument.

Figure 96 shows 4 detected instruments:

- One C1000 thermal cycler with a dual 48/48 reaction module
- One S1000 thermal cycler with a dual 48/48 reaction module
- Two S1000 thermal cyclers, each with a single reaction module

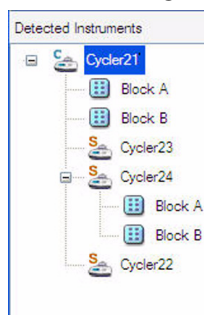

Figure 96. Instruments listed in the Detected Instruments pane.

See “Monitoring a Run” on page 74 for details how to check on the status of attached instruments.

Creating or Editing a Protocol

To create a new protocol:

1. Select **Create New** on the **Run/Edit Protocol** screen, or select **New** from the **File** menu. The **Protocol Editor - New** screen, which is an editable protocol template, opens.
2. Select a step parameter (e.g., time or temperature) to enter the parameter.
3. Select **Insert Step**, **Insert Gradient**, or **Insert GOTO** to insert a new step below (or to the right of) the highlighted step. Select **Delete Step** to remove a step.
4. Select **OK** to save the protocol (Figure 97).

TIP: To create a new protocol if the annealing temperature is not known, go to **Tools > Protocol AutoWriter** or **Tools > Ta Calculator**. This opens the **Ta Calculator** window. Alternatively, click on the **Protocol AutoWriter** icon located on

the main toolbar. For more details on using the Protocol AutoWriter software, see “Creating a Protocol with the Protocol AutoWriter” on page 48.

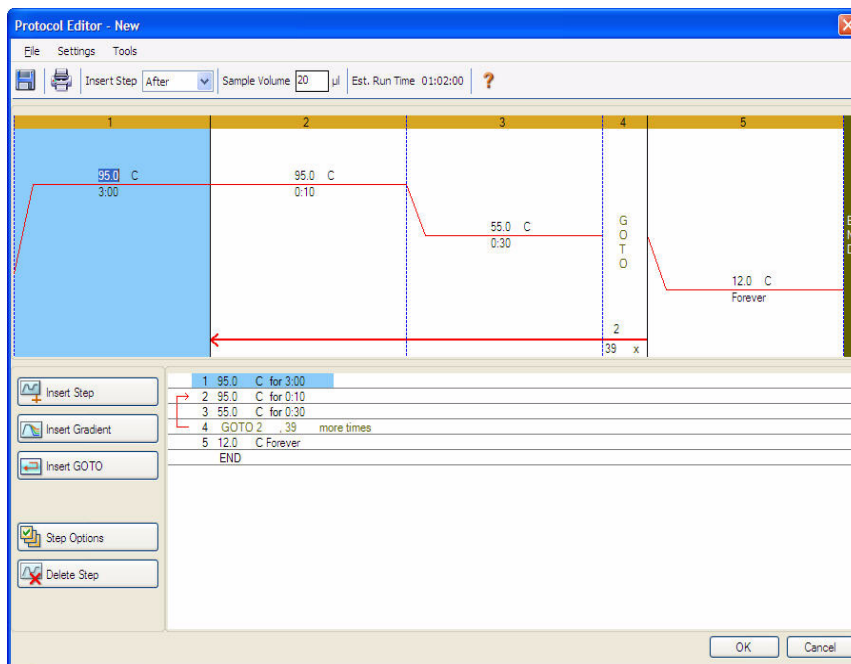

Figure 97. Creating or editing a protocol.

To edit an existing protocol:

1. Choose **Select Existing** on the **Run/Edit Protocol** screen or **Existing** from the **File** menu. Alternatively, select a protocol from the **Express Load** drop-down menu.
2. Select **Edit**.
3. Select a step parameter (e.g., time or temperature) to be edited.
4. Select **Insert Step**, **Insert Gradient**, or **Insert GOTO** to insert a new step below (or to the right of) the highlighted step. Select **Step Options** to add a temperature increment/decrement or to change the dwell time of a step. Select **Delete Step** to remove a step.
5. Select **OK** to save the protocol.

Running a Protocol

1. Create a new protocol or edit an existing protocol (see “Creating or Editing a Protocol” on page 72).
2. Select the **Start Run** tab on the **Protocol** tab of the **Run/Edit Protocol** screen. All the attached reaction module blocks are displayed.

3. Select the block or blocks you want to run (Figure 98).

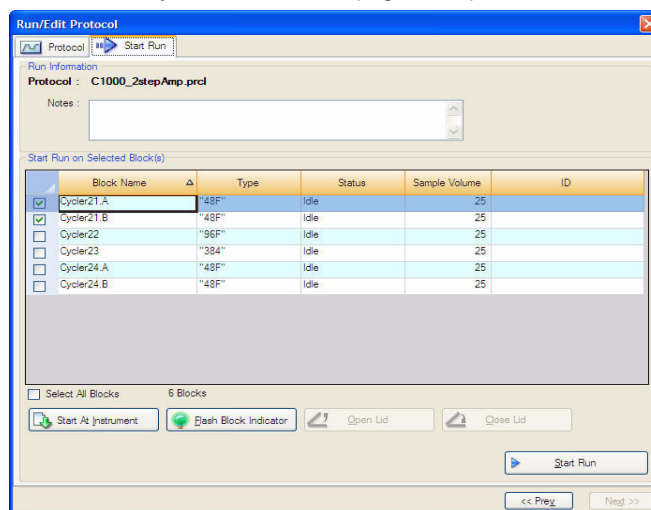

Figure 98. Running a protocol.

4. To start the run on selected blocks immediately, click **Start Run**. Alternatively, select the **Start At Instrument** option to start the run at the instrument (Figure 99).

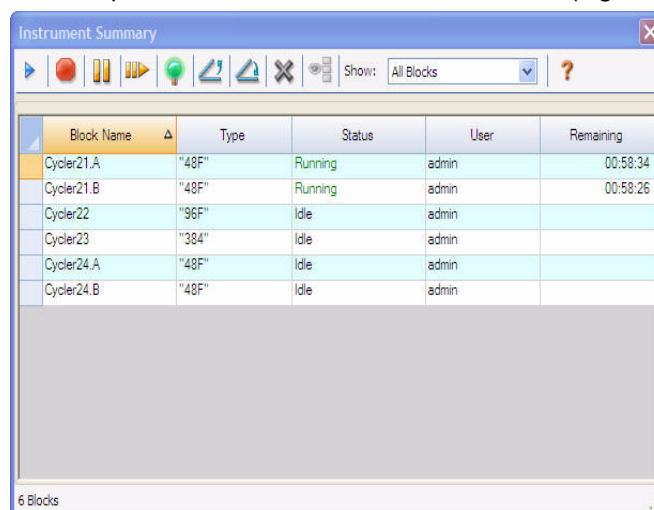

Figure 99. Instrument Summary window.

Monitoring a Run

The C1000 Manager can be used to monitor the progress of individual blocks/instruments from a central screen. To monitor a run, follow the following instructions:

1. When a run begins, the **Instrument Summary** window automatically appears. Review the information in this window to monitor the progress of a run. This window can also be accessed from the **View Summary** option located at the bottom left side of the screen.

NOTE: You can show all detected blocks, all idle blocks, all the blocks that are running with the current user, or all running blocks by selecting the appropriate option from the drop-down menu at the top of the **Instrument Summary** window.

2. Select the appropriate instrument from the list and press **View Status** from the bottom left side of the screen. Alternatively, double-click on an instrument/block from the tree in the Detected Instruments pane to open the same window.
3. When the **Run Details** screen appears (Figure 100), select the **Run Status** tab to check the current status of the selected block, pause the run, stop a run, or skip a step.

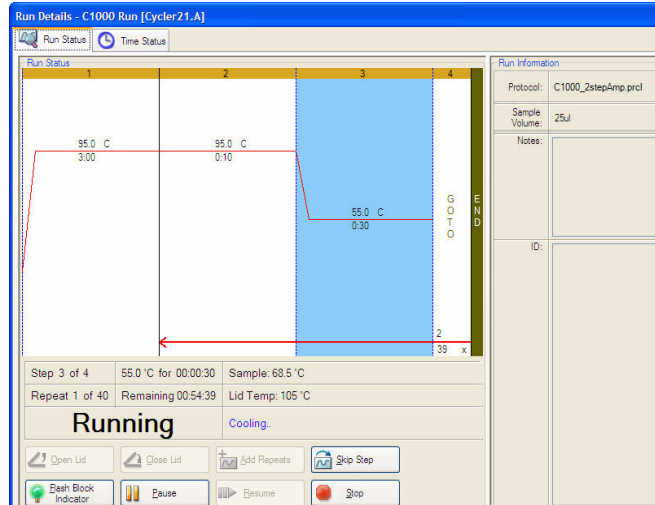

Figure 100. Run Details window.

4. Select the **Time Status** tab to see a full-screen count-down timer for the protocol (Figure 101).

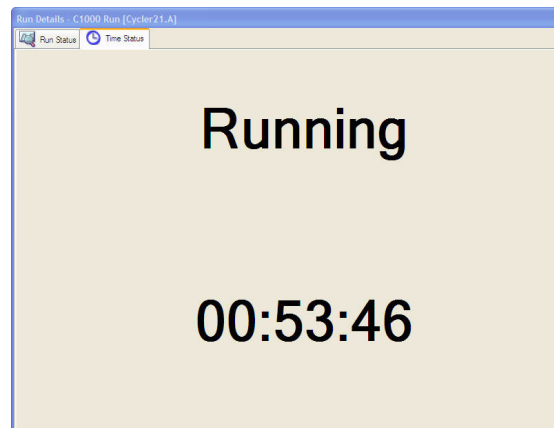

Figure 101. Count-down timer for the protocol.

Copying and Running Protocols from a USB Key

The C1000 Manager software enables you to write and optimize protocols at your desk, and transfer them to your C1000 thermal cycler using a USB key. Simply plug the USB key into a USB A port of a C1000 thermal cycler and start running the protocol.

User Preferences

C1000 Manager software can be used to create and manage user preferences. The software tracks the preferences of each user that logs onto the software. To customize software settings, open the **User Preferences** window (Figure 102) using one of these methods:

- Select **User Preferences** in the main software window toolbar
- Select **User > User Preferences** in the main software windows menu bar
- Select one of the tabs (**Email**, **Files**, or **Protocol**) to view or change preferences.

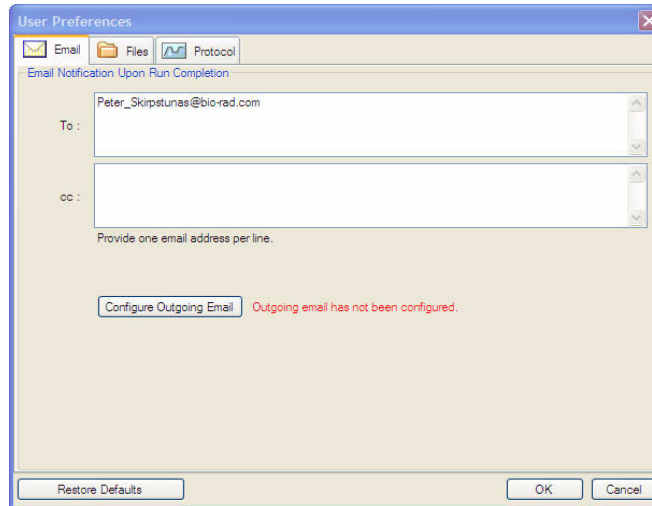

Figure 102. User Preferences window.

TIP: Select **Restore Default** to restore all settings to the default settings shown in this image. Then Select **OK** to save the settings, and close the window.

Email Preferences Tab

To configure email notifications under software control, follow these instructions:

1. Select the **Configure Outgoing** email option on the **Email** tab of the **User Preferences** window. The **Options** window opens (Figure 103).

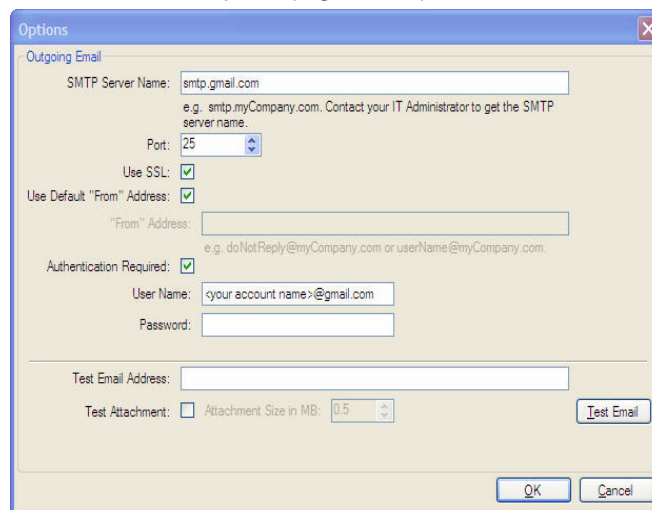

Figure 103. Options to configure email.

2. Contact your IT administrator to configure the SMTP server and send a test email from the computer. The following information needs to be included in this screen:

- **SMTP Server Name** — the name of the SMTP Server as provided by your IT administrator
- **Port** — the port number of your SMTP Server, as provided by your IT administrator. This is usually 25
- **Use SSL (Secure Sockets Layer)** — some SMTP servers require this to be used, others require that it not be used
- **Use Default “From” Address** — this can usually be left in the default checked state. However, some SMTP servers require all sent email to have a “from” address that is from a certain domain, i.e. <name>@YourCompany.com. If this the case, this box must be unchecked, and a valid “from” email address must be supplied in the box labeled “From” Address
- **Authentication Required** — many SMTP servers require authentication. If so, this box must be checked, and a user name and password must be supplied
- **Test email** — to test an email setting, enter one or more email addresses in **Test Email Address** box. (Multiple email addresses can be separated by a comma.) Then select **Test Email**. If the test email is successfully sent, return to the **User Preferences/Email** tab and input an email address where the notification will be sent

NOTE: Some SMTP servers do not allow attachments, and others allow attachments of up to a certain size. Test your server’s ability to email attachments by checking the **Test Attachment** box, and setting the **Attachment Size** between 0.5 to 1 megabyte (MB).

Files Preferences Tab

Select the **Files** tab to list the default locations for opening and saving files.

- **Default folder for File Creation.** Select a default folder where you want to save new protocol files.
- **File Selection for Experiment Setup.** Select the default protocol file that appears when you open the **Experiment Setup** window (Figure 104).

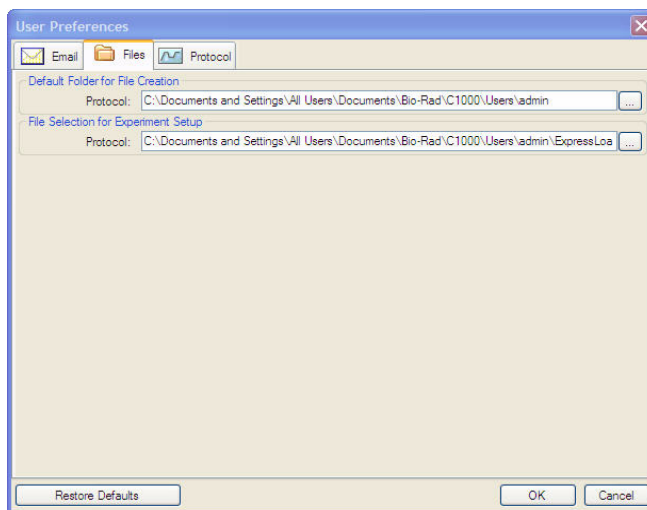

Figure 104. The Files Preferences tab in the User Preferences window.

Protocol Preferences Tab

Select the Protocol tab in the User Preferences window to specify the default settings for a new protocol file in the Protocol Editor window:

- **Protocol Editor.** Set the default settings that appear in the Protocol Editor window. Select a default **Sample Volume** to describe the volume of each sample in the wells (in μl). Select a value for the temperature in the **Shutoff lid when Block Temperature goes below** field
- **Protocol AutoWriter.** Select default settings that appear in the Protocol AutoWriter, including default **Annealing Temperature** for experiments that use iProof or iTaq DNA polymerase, or other polymerases and the default **Amplicon Length**

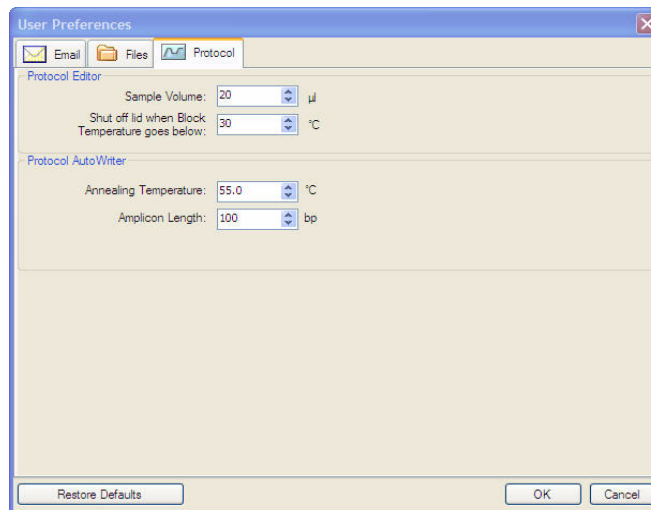

Figure 105. The Protocol Preferences tab in the User Preferences window.

TIP: Select **Restore Default** to restore all settings to the default settings shown in this image. Then select **OK** to save the settings, and close the window.

Managing Users

Open the **User Administration** window in the main software window using one of the following methods:

- Select **User > User Administration**
- Select **User Administration** in the main menu bar

When logged in as the **Administrator**, open the **User Administration** window to manage users and user rights:

- **Manage Users.** Add or remove users, and assign each user a role
- **User Rights.** Change rights for user roles (Principal, Operator, or Guest)

NOTE: Only the Administrators can edit this window. Other users can only view.

To assign a role for each user, see “Assigning Rights for User Roles”.

Adding and Removing Software Users

Only a software Administrator can add or remove users.

To add software users in the **Manager Users** pane:

1. Enter a **User Name** for the new software user.
2. Select a **Role** for the user. These roles restrict the rights of each user. The default is **Principal**.
3. (Optional) Enter a **Full Name** and **Password** for the new software user.
4. Select **OK** to open a dialog box and confirm that you want to close the window.
5. Select **Yes** to close the dialog box and window.

To remove a software user, follow these steps:

1. In the **Manage Users** pane, select the box in the **Delete** list for each software user you want to remove.
2. Select **OK** to open a dialog box and confirm that you want to close the window.
3. Select **Yes** to close the dialog box and window.

NOTE: The list of software users must always include one Administrator.

Assigning Rights for User Roles

The **User Administration** window provides access to user roles and rights. The software includes these four roles:

Administrator (required). Each Administrator has all rights, which cannot be changed. The administrator can also add or remove software users, and change the rights for each role

Principal. By default each Principal has all rights

Operator. By default each operator has all rights, except skipping cycles

Guest. By default each Guest has no additional rights, and can only read files

To specify the rights for each role:

1. In the **Manage Rights** pane, select a box under the name of the role to add or remove that right. Select one or more rights in the list. To change all the rights for all the roles to the default list, select **Restore Default Rights**.
2. Select **OK** to open a dialog box and confirm that you want to close the window.
3. Select **Yes** to close the dialog box and window.

8 Advanced Functions

Read this chapter for information on advanced functions on the C1000 thermal cycler.

- Logging into or logging off the C1000 thermal cycler (below)
- Utilities menu (page 83)
- Administrator settings menu (page 85)
- SYSTEM folder functions (page 86)
- Using data ports on the C1000 thermal cycler (page 86)
- Controlling S1000 thermal cyclers with the C1000 thermal cycler (page 86)

Logging Into or Logging Off the C1000 Thermal Cycler

Logging into the C1000 thermal cycler is optional. A user can run, edit protocol templates, and create folders and protocols without first logging in. When a user selects the **Add New User** option, a corresponding folder under **Users** is created automatically. Only a user who is logged in can save, **edit**, or delete protocols.

Once logged in, a user has privileges to:

- Run a protocol in the MAIN or USERS folder
- Create and edit protocols in the corresponding USERS folder
- Copy any protocol and save it to a USERS folder
- Copy a protocol and store it in a USERS folder with a new name

Use the following steps to log in to or log off the C1000 thermal cycler:

1. Select **Log In** from the main menu and select a user name using the up and down arrows (Figure 106).

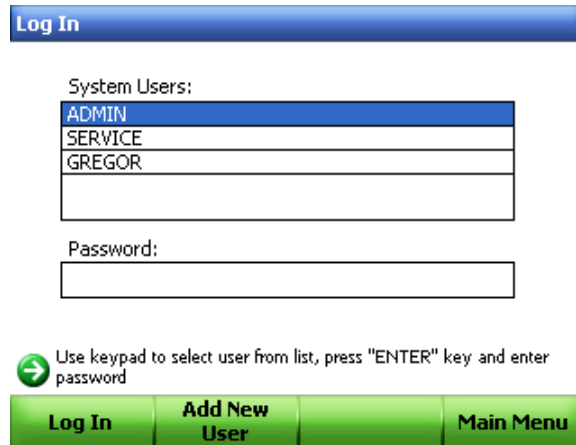

The screenshot shows a 'Log In' screen with a blue header bar. Below the header, there is a 'System Users:' section with a list box containing 'ADMIN', 'SERVICE', and 'GREGOR'. The 'ADMIN' user is currently selected. Below the list box is a 'Password:' field. At the bottom, there is a green bar with three buttons: 'Log In', 'Add New User', and 'Main Menu'. A green arrow icon points to the right, followed by the text: 'Use keypad to select user from list, press "ENTER" key and enter password'.

Figure 106. Select a user name using the up and down arrows.

2. Enter the password, and then press **F1** or click **Log In** (Figure 107).
NOTE: A password can contain a combination of letters and numbers.

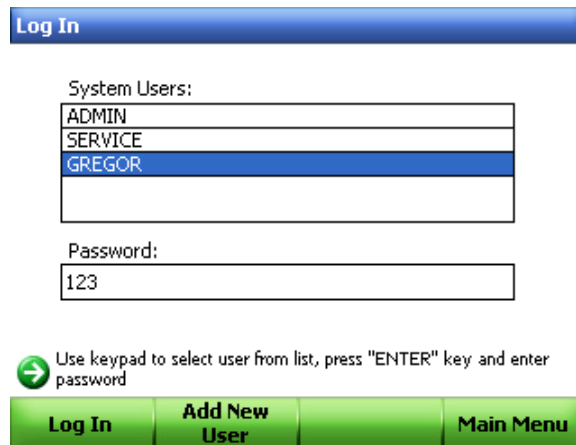

The screenshot shows the 'Log In' screen with the 'System Users:' list box now containing 'ADMIN', 'SERVICE', and 'GREGOR'. The 'GREGOR' user is selected. The 'Password:' field now contains the text '123'. The green bar at the bottom with the 'Log In', 'Add New User', and 'Main Menu' buttons remains. The green arrow icon and text are also present.

Figure 107. Enter the password and click Log In.

3. Click **Main Menu** to return to the main menu.

4. To log off the thermal cycler, press **F1** or select **Log Off** in the main menu (Figure 108).

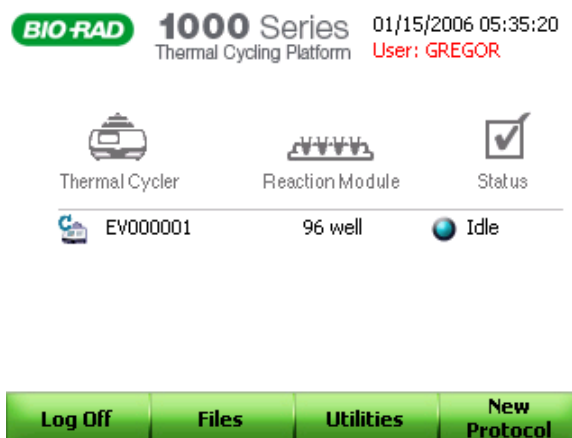

Figure 108. Select Log Off in the main menu to log off the thermal cycler.

Utilities Menu and Functions

The **Utilities** Menu provides a list of functions that control the C1000 thermal cycler as shown in Figure 109.

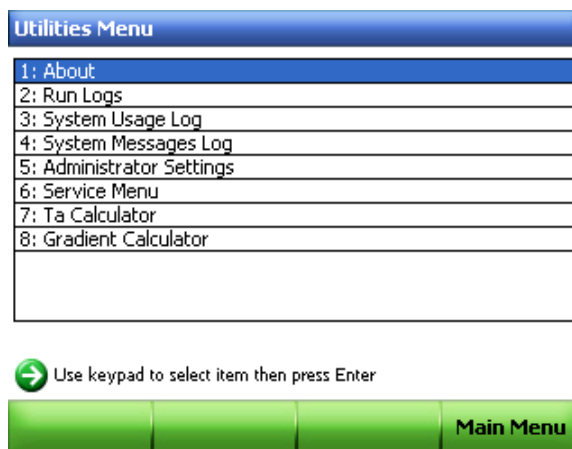

Figure 109. The Utilities menu.

The functions in the **Utilities Menu** offer the following options:

- **About** — for viewing the current firmware versions and serial numbers
- **Run Logs** — for viewing the run log for each time a protocol is run. Logs can also be copied onto a USB key (for use when servicing the cycler)
- **System Usage Log** — for viewing a log that contains a list of all events that occurred during each run
- **System Messages Log** — for viewing messages that occurred during all runs
- **Administer Settings** — for opening the Administrator functions (page 85); only a logged in Administrator has access to Administrative settings.
- **Service Menu** — to be accessed by service personnel from Bio-Rad Laboratories

- **T_a Calculator** — for viewing and using the T_a calculator to calculate the melting temperature for a pair of primers
- **Gradient Calculator** — for calculating a temperature gradient across a block

Gradient Calculator Function

The **Gradient Calculator** screen displays the thermal gradient across a block. Use this calculator to view the temperature in a specific well or row.

To calculate and view the thermal gradient on the block,:

1. Open the **Utilities Menu**.
2. Select **Gradient Calculator**.
3. Enter the values for the **Temperature** and **Gradient Range** (Figure 110).

The screenshot shows the 'Gradient Calculator' interface. It features two input fields: 'Temperature' with the value '50.0' and 'Gradient Range' with the value '10.0'. To the right is a table titled 'Gradient' with columns for well letters (A-H) and their corresponding values. Below the table is a green button with a right-pointing arrow and the text 'Use Keypad to navigate between the rows.'. At the bottom are two green buttons: 'Show 384 Gradient' and 'Main Menu'.

		Gradient
Temperature	50.0	A 60.0
Gradient Range	10.0	C B 59.4
		C 58.3
		D 56.3
		E 53.9
		F 52.0
		G 50.7
		H 50.0

Figure 110. Enter values in the Temperature and Gradient Range fields.

Administrator Settings Menu

The **Administrator Settings Menu** contains all the functions needed to set access levels and system defaults for the C1000 thermal cycler. Open this list by selecting **Administrator Settings Menu** in the **Utilities** list, and pressing **ENTER**. Figure 111 shows options listed in the **Administrator Settings Menu**.

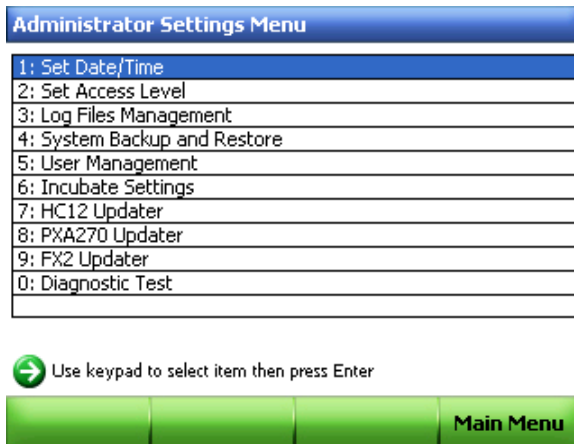

Figure 111. The Administrative Settings Menu.

NOTE: Only a logged in Administrator may access the **Administrator Settings Menu**.

The Administrator Settings menu contains these options:

- **Set Date/Time** — for setting the date and time on the thermal cycler
- **Set Access Level** — for setting the user access levels to **Open** or **Secured**
- **Log Files Management** — for clearing or trimming log files
- **System Backup and Restore** — for backing up or restoring system settings from a USB key
- **User Management** — for adding or removing users and clear passwords
- **Incubate Settings** — for setting the default incubate settings for the lid temperature, lid cut-off, and incubation temperature
- **HC12 Updater, PXA270 Updater, FX2 updater** — for updating the firmware on the thermal cycler
- **Diagnostic Test** — for performing a series or subset of diagnostic self tests on the cycler (for use when servicing the cycler)

SYSTEM Folder Functions

The **SYSTEM** folder provides access to system-wide templates and data. Figure 112 shows the contents of the **SYSTEM** folder.

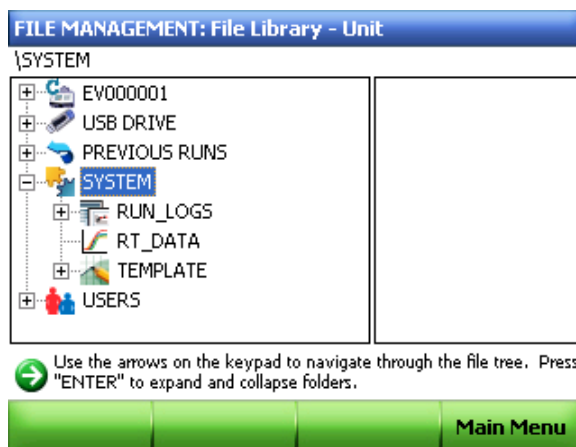

Figure 112. The SYSTEMS folder.

The folders within the **SYSTEM** folder provide access to these functions:

- **RT_DATA** — for viewing real-time data collected with the CFX96 or CFX384 real-time detection instruments
- **Run Logs** — for viewing or downloading run logs
- **Template** — for editing or creating the default protocol file for the thermal cycler

Using Data Ports on the C1000 Thermal Cycler

The C1000 thermal cycler has several data ports that can be used to transfer data to and from the thermal cycler:

- **A USB A port below the control panel** — for transfer data to and from a USB key, or to attach a USB mouse or keyboard
- **A USB B computer port on the back panel** — for connecting a C1000 thermal cycler to a computer
- **Four USB A ports located on the back panel** — for connecting up to **three** S1000 thermal cyclers; can also be used to connect a USB key, mouse, keyboard, or barcode reader
- **A serial test port on the back panel** — for testing the thermal cycler by service personnel or to connect the thermal cycler to a network

Controlling S1000 Thermal Cyclers with the C1000 Cycler

Up to **three** S1000 thermal cyclers can run under the control of a C1000 thermal cycler. Each S1000 thermal cycler can be connected to the C1000 thermal cycler through the USB A port of the C1000 thermal cycler.

When connected to a C1000 thermal cycler, the S1000 thermal cyclers can be controlled by either the control panel on the C1000 thermal cycler or the C1000 Manager software.

The following sections provide instructions on connecting and operating an S1000 thermal cycler using a C1000 thermal cycler:

- Connecting S1000 thermal cyclers directly to a C1000 thermal cycler via the USB A port (below)
- Operating S1000 thermal cyclers while under the control of a C1000 cycler (page 87)

For detailed instructions on running the S1000 thermal cycler when it is connected to a C1000 thermal cycler, refer to the instruction manual for the S1000 thermal cycler or see “Controlling Thermal Cyclers Using C1000 Manager Software” on page 71.

Connecting S1000 Cyclers Directly to a C1000 Cycler

To connect up to three S1000 thermal cyclers directly to a C1000 cycler, follow these instructions:

1. Plug a high quality, shielded USB cable into the USB B port on the back of the S1000 thermal cycler.
For USB cable part number, see page 106.
2. Plug the other side of the USB cable into a USB A port on the back of the C1000 thermal cycler.
The C1000 instrument detects the attached S1000 thermal cycler.
3. Repeat steps 1 and 2 to connect up to three S1000 cyclers directly to the same C1000 thermal cycler.
4. Open the MAIN screen or instrument tree on the C1000 thermal cycler, or in the C1000 Manager software if the C1000 thermal cycler is connected to a computer.
5. Select the S1000 thermal cycler by serial number or name.
NOTE: If the S1000 thermal cycler instrument has a name, then the name is displayed instead of the serial number.

Operating the S1000 Thermal Cycler While Under the Control of the C1000 Cycler

When the S1000 thermal cycler is under the control of the C1000 cycler, it is in “semi-lock down mode”. In this mode, the S1000 thermal cycler does not respond when control panel keys are pressed. However, the following keys function on the control panel:

- **SCREEN** — to access the running, graphical, and time remaining screens
- **PAUSE** — to temporarily stop a protocol that is currently running on the S1000 thermal cycler. This function is active when an individual protocol screen is being displayed
- **CANCEL** — to cancel a protocol that is currently running on the S1000 thermal cycler. This function is active when an individual protocol screen is being displayed
- **ENTER** — to begin a run that has been remotely sent from the C1000 Manager software
- **ENTER** — to skip a step. This function is active when an individual protocol screen is being displayed

9 Maintenance and Troubleshooting

Read this chapter for information on maintaining the C1000 thermal cycler and troubleshooting problems.

- Cleaning and maintaining the C1000 thermal cycler (below)
- Maintaining sufficient air flow (page 91)
- Troubleshooting error messages on the C1000 thermal cycler (page 92)

Cleaning and Maintaining the C1000 Thermal Cycler

The C1000 thermal cycler requires little maintenance for proper operation and precise thermal control. However, with long and constant use, the thermal cycler requires some cleaning and other maintenance. Information on cleaning the thermal cycler base and reaction module is included in this chapter. In addition, instructions on replacing the fuses are provided.

TIP: For robotic installations where many instruments run constantly, perform a regular check for dust, spills, and debris that could interfere with optimal instrument performance.

Cleaning the C1000 Thermal Cycler

The C1000 thermal cycler should be cleaned on a regular schedule to remove any debris or dirt that might interfere with proper function. Clean the base to prevent damage to the air intake or reaction module bay.

NOTE: For instructions on handling and cleaning radioactive or biohazardous materials, consult the guidelines for radiation safety and biosafety provided by your institution. These guidelines include cleaning, monitoring, and disposal methods for hazardous materials.

To clean the thermal cycler base, follow the instructions below, paying careful attention to the warnings:

WARNING! To prevent electrical shock, always turn off and unplug the instrument before cleaning it.

- **Clean the air vents.** Remove dust with a soft brush, damp cloth, or vacuum cleaner. Remove any heavy dust that is deep in the vents with a vacuum cleaner. Cleaning the vents allows sufficient air flow for precise thermal control during a run

- **Clean the control panel.** Remove debris on the control panel with a soft cloth and mild soap solution. Cleaning the panel prevents debris that may obscure the display
WARNING! Do not use abrasive detergents or rough material since they scratch the control panel.
- **Clean the reaction module bay.** Clean with a damp soft cloth to remove debris and spilled liquids. Cleaning the bay allows precise heating and cooling of the reaction block
WARNING! Never use cleaning solutions that are corrosive to aluminium. Avoid scratching the surface of the bay, which interferes with precise thermal control.
WARNING! Never pour water or other solutions in the reaction module bay. Wet components can cause electrical shock when the thermal cycler is plugged in.
- **Clean the outside case of the thermal cycler base.** Use a damp cloth or tissue to clean spills off the outside case. If needed, use a mild soap solution and remove the residue completely. Cleaning the outside case prevents corrosion

Cleaning the Reaction Modules

Clean the reaction modules of the C1000 thermal cycler on a regular schedule to prevent reagents from accumulating and interfering with the ability of the reaction block to change temperature quickly.

To clean the reaction module, follow these instructions, paying careful attention to the warnings:

WARNING! To prevent electrical shock, always remove the reaction module from the thermal cycler base before cleaning it.

- **Clean the cooling fins.** Remove dust from the cooling fins with a soft brush or damp cloth. Remove any heavy dust that is deep in the fins with a vacuum cleaner. Use water and a soft cloth to remove debris that is stuck to the fins. Avoid scratching the surface. Never use cleaning solutions that are corrosive to aluminum, such as bleach or abrasive cleansers. If needed, use a mild soap solution and rinse well to remove the residue completely. Cleaning the fins improves precise sample heating and cooling
- **Clean the outside cover of the reaction block.** Use a soft cloth and water to remove debris from the outer block
WARNING! Never clean the block with strong alkaline solutions (strong soap, ammonia, or high-concentration bleach). Never use corrosive or abrasive cleaning solutions. These cleaning agents can damage the block and prevent precise thermal control.
- **Clean the block wells.** Clean spills immediately to prevent them from drying inside wells. Use disposable plastic pipets with water (recommended), 95% ethanol, or a 1:100 dilution of bleach in water. Always rinse the wells with water several times to remove all traces of ethanol, bleach, or soap
WARNING! If left in the block wells, bleach, ethanol, or soap could corrode the block and/or destroy tubes and microplates during a run. Always rinse the block well after cleaning it with any solution other than water.
- **If oil is used, the wells must be cleaned thoroughly and often.** Use of oil in the wells is not recommended. Clean the oil when it is discolored or contains dirt. Use a solution of 95% ethanol to clean oil. Do not allow oil to build up in the block
WARNING! Never heat the block after adding a cleaning solution. Heating the block with cleaning solution damages the block, lid, and thermal cycler base.
- **Clean the inner of the reaction module.** Use a soft cloth and water to remove debris and solutions from the inner lid surface. Never use abrasive detergents or rough material

that scratch the surface. Cleaning the inner lid improves precise sample heating and cooling

- **Clean the outer lid surface of the reaction module.** Use a damp cloth or tissue to clean spills off the outside case. If needed, use a mild soap solution and rinse the surface with a damp cloth. Cleaning the cover prevents corrosion

Maintaining Sufficient Air Flow

The C1000 thermal cycler requires sufficient air flow to precisely heat and cool to the correct target temperature. If the flow of air is blocked the thermal cycler cannot ramp to the correct temperature in the specified time. This section includes instructions for testing the air flow and provides suggestions for fixing low or warm air flow.

Testing for Sufficient Air Flow

The air flow is sufficient when the thermal cycler heats and cools to the correct target temperatures promptly. When the C1000 thermal cycler is first set up in a new location, use the following steps to determine the presence of sufficient air flow:

1. Set up the instrument in the location where it is going to be used, then turn the power on.
2. Adjust the local environment for typical conditions.
Turn on any nearby equipment, such as fans. Also open any window blinds to reproduce typical conditions during a run. If more than one thermal cycler is in the area, run a protocol on all the thermal cyclers at the same time.
3. Run a typical PCR protocol for 30 min.
To run a protocol, samples are not required; however, an empty microplate or tubes should be included. The lid does not heat correctly if it touches the hot block of the reaction module.
4. Measure the air temperature at the air intake vents of all the thermal cyclers.
If the air intake temperature increases above 31°C, see “Fixing Insufficient Air Flow” to ensure sufficient air flow.

Fixing Insufficient Air Flow

If the air temperature near the thermal cycler is above 31°C, make one or more of the following changes to increase the flow of cooler air around the thermal cycler:

- Adjust air conditioning to lower the ambient air temperature
- Move the thermal cycler to another location
- Provide more space around the C1000 thermal cycler and between adjacent instruments. Arrange instruments so that the warm exhaust air from one instrument does not enter the air intake vents of another
- Shield the thermal cycler from heat sources, such as radiators, other heat-producing instruments, and bright sunlight

Replacing Fuses

Fuses on the C1000 thermal cycler are designed to blow in case of severe power surges or other causes of electrical short. This process protects both the user and the instrument from excessive electric charge. Fuses on the C1000 thermal cycler rarely need to be replaced. However, some institutions prefer to replace fuses on a regular basis to maintain uninterrupted operation.

If the thermal cycler does not turn on, first check that the power cord is plugged in to a functioning power source. Also, check that the power cord and power source are within the specifications for this instrument. To replace a power cord, contact Bio-Rad Technical Support (for more details, see “Bio-Rad Laboratories Resources” on page iii).

Finally, check that the fuses are intact. The C1000 thermal cycler runs with two fuses (Figure 113) that have specifications listed in “Operating specifications for the C1000 thermal cycler” on page 109. To remove and check the fuses, follow these steps:

WARNING! To prevent electrical shock, always turn off and unplug the instrument from an electrical outlet before checking the fuses.

1. Use a small coin to unscrew the fuse drawer.

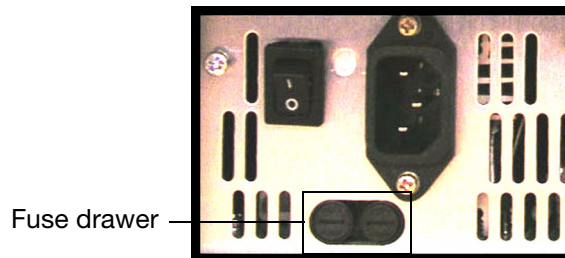

Figure 113. The fuse drawer on the back of the C1000 thermal cycler.

2. Pull out the fuse drawer and remove each fuse.
3. If a fuse is damaged, replace it with the correct fuse, and close the drawer.
A bad fuse shows a break or burned spot in the metal. A good fuse has intact metal.

Troubleshooting Error Messages on the C1000 Cycler

In general, when the C1000 thermal cycler displays a warning or error message, the instructions for fixing the problem are contained in the message.

Warning and Error Messages

A warning or error message is displayed when external power fails during a run (Figure 114). This error message displays what protocol was running, when the protocol stopped due to the power failure, and the block temperature when the thermal cycler resumed the run.



Figure 114. An error message alerting that the protocol was interrupted.

NOTE: A power failure can change the outcome of a PCR run. The hold time for the step that was running when the power failed is lengthened, causing the sample to deviate from the target temperature until the power resumes.

The C1000 thermal cycler tracks errors that occur during a run. After a run, all messages are displayed. For example, when a run is cancelled, the **PROTOCOL CANCELLED** screen is displayed as shown in Figure 115.

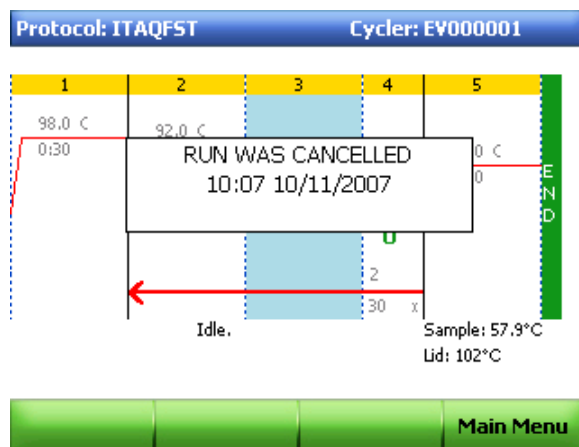

Figure 115. The PROTOCOL CANCELLED screen.

To clear a message or error and continue to the next screen, press **ENTER**. When all messages are cleared, the C1000 thermal cycler returns to the **Main Menu**.

Error messages are recorded in the **Run Logs** as listed in Table 13.

TIP: The C1000 thermal cyclor also tracks errors and system messages for all attached S1000 thermal cyclor.

Table 13. Warning and error message on the C1000 thermal cyclor and possible solutions

Message	Cause
Running On A A/C Power Failed Power Outage During Cycle X Step Y Restarted At Zz.z Press Any Key To Clear This Message	Displayed when a machine running a protocol is turned off, either intentionally or due to a power outage, and then turned on again.
Please restart cyclor. Block overheated. Please call Bio-Rad for service.	Reaction module has exceeded maximum temperature of 107.5°C, or sensor has a malfunction and is not measuring temperature accurately. Protocol terminated.
Please restart cyclor. Teosinte overheated. Please call Bio-Rad for service.	Teosinte temperature has exceeded 75°C. Protocol terminated.
Please restart cyclor. System overheated. Please call Bio-Rad for service.	Amplifier 1 temperature has exceeded 85°C. Protocol terminated.
All block sensors failed. Please call Bio-Rad for service.	All block sensors have failed. Protocol terminated.
Power supply overheated. Please call Bio-Rad for service.	Power Supply temperature has exceeded 85°C. Protocol terminated.
Heated lid failed. Protocol cancelled. Please call Bio-Rad for service.	Lid sensor has failed during lid preheat. Protocol terminated.
Internal fan failed. Please call Bio-Rad for service.	<unused at present>
Heatsink overheating. Please check air flow. Please call Bio-Rad for service.	Heatsink has exceeded 70°C. System beeps and displays error.
Please check air flow. System overheating. Please call Bio-Rad for service.	Amp temp has exceeded 80°C. System beeps and displays error.
Please check air flow. Power supply overheating. Please call Bio-Rad for service.	Power Supply temperature has exceeded 80°C. System beeps and displays error.
Slow block cycling. Please call Bio-Rad for service.	Block failed to achieve target in the estimated time.
Slow lid cycling. Please call Bio-Rad for service.	Lid failed to achieve target in the estimated time.
Slow gradient. Please call Bio-Rad for service.	Block failed to achieve gradient in the estimated time.

Table 13. Warning and error message on the C1000 thermal cycler and possible solutions (continued)

Message	Cause
Heated lid failed. Please call Bio-Rad for service.	(singles only) If the right and left lid heater channels deviate from each other by more than 5°C, the lid is shut off.
Block sensor 0 failed. Please call Bio-Rad for service.	Block sensor 0 has failed* and the protocol was terminated.
Block sensor 1 failed. Please call Bio-Rad for service.	Block sensor 1 has failed* and the protocol was terminated.
Block sensor 2 failed. Please call Bio-Rad for service.	Block sensor 2 has failed* and the protocol was terminated.
Block sensor 3 failed. Please call Bio-Rad for service.	Block sensor 3 has failed* and the protocol was terminated.
Block sensor 4 failed. Please call Bio-Rad for service.	Block sensor 4 has failed* and the protocol was terminated.
Block sensor 5 failed. Please call Bio-Rad for service.	Block sensor 5 has failed* and the protocol was terminated.
Left lid sensor failed. Please call Bio-Rad for service.	Left lid sensor has failed*. If a dual, protocol terminated. If a single and both lid sensors failed, protocol terminated and block sent to 4°C.
Right lid sensor failed. Please call Bio-Rad for service.	Right lid sensor has failed*. If a dual, protocol terminated. If a single and both lid sensors failed, protocol terminated and block sent to 4°C.
Left heatsink sensor failed. Please call Bio-Rad for service.	Left heatsink sensor has failed*, system using average of amplifier temperatures to continue.
Right heatsink sensor failed. Please call Bio-Rad for service.	Right heatsink sensor has failed* system using average of amplifier temperatures to continue.
Lid overheated and was shut off. Please call Bio-Rad for service.	(for dual 48/48 reaction module only) Lid has overheated and has been shut off, and protocol has been terminated.
Amplified 1 temperature sensor failed. Please call Bio-Rad for service.	Amplifier temperature sensor 1 has failed*.
Power supply sensor failed. Please call Bio-Rad for service.	Power Supply sensor has failed*.
Block power failure. Protocol cancelled. Please call Bio-Rad for service.	Power to block is out of range.
Logic power failure. Please call Bio-Rad for service.	Logic power sensor is out of bounds.
Base power failure. Protocol cancelled. Please call Bio-Rad for service.	Base power sensor is out of bounds. Protocol cancelled.

Table 13. Warning and error message on the C1000 thermal cycler and possible solutions (continued)

Message	Cause
Amplifier 2 sensor failed. Please call Bio-Rad for service.	Amplifier temperature sensor 2 has failed*.
Corrupt protocol memory detected. Protocols may be lost. Please call Bio-Rad for service.	Protocol storage memory has been corrupted.
Unable to read reaction module header. Please restart cycler. Please call Bio-Rad for service.	Unable to read information from reaction module properly.
Please restart cycler. Incorrect checksum. Please call Bio-Rad for service.	Information read from reaction module appears incorrect.
Please restart cycler. Block power was shut off. Please call Bio-Rad for service.	There was a problem with the block and power was shut off.
One of the block sensors in a single block has failed. The system has cancelled the protocol and sent the block to 4°C to preserve the samples. Please call Bio-Rad for service.	One of the block sensors in a single block has failed. The system has cancelled the protocol at step X , cycle Y and sent the block to 4°C to preserve the samples.

The error message may instruct the user to contact Bio-Rad. In this event, call the nearest Bio-Rad Laboratories Technical Support team (see “Bio-Rad Laboratories Resources” on page iii for more detail).

*Sensor Failure means that the sensor was deemed short, open or had changed more than 3°C in a 50 msec period and that this condition was present for more than 2 sec.

If two or more block sensors fail (or both lid sensors fail), the protocol is terminated and the block is sent to 4°C to preserve samples.

Appendix A: Preinstalled Protocols

Standard Protocols

The C1000 thermal cycler is packaged with two standard protocols that run two-step and three-step PCR with a standard DNA polymerase. Use these protocols to begin running PCR with new primers and DNA template, or copy them to begin writing a new protocol. Table 14 lists the parameters in each standard protocol.

Table 14. Standard protocols

	STD2		STD3	
	Standard Two-Step Protocol		Standard Three-Step Protocol	
Step	Target Temperature (°C) or GOTO Step	Time (min:sec) or Repeats	Target Temperature (°C) or GOTO Step	Time (min:sec) or Repeats
1	95	3:00	95	3:00
2	95	0:30	95	0:30
3	65	0:30	55	0:30
4	GOTO 2	29x	72	0:30
5	72	7:00	GOTO 2	29x
6	12	Infinite hold ∞	72	1:00
7	END		12	Infinite hold ∞
8			END	

Touchdown Protocol

A touchdown protocol tests for the best annealing temperature for a specific primer-template pair. Choose this protocol to test a new set of primers and DNA template for the optimal annealing temperature. Table 15 lists the parameters of the preinstalled touchdown protocol.

Table 15. Touchdown protocol

TCHDOWN		
To Identify the Optimal Annealing Temperature		
Step	Target Temperature (°C) or GOTO Step	Time (min:sec) or Repeats
1	95	3:00
2	95	0:30
3	60 (increment at -0.5°C/ cycle)	0:30
4	72	0:30
5	GOTO 2	29x
6	95	0:30
7	45	0:30
8	72	0:30
9	GOTO 6	29x
10	72	7:00
11	12	Infinite hold ∞
12	END	

Optimized Protocol Using iTaq Polymerase

iTaq DNA polymerase is an antibody-mediated hot-start polymerase that is suitable for both PCR and real-time. iTaq polymerase is designed to be activated during the first step at 98°C and to amplify small to medium-size templates. The iTaq protocol runs PCR using the optimal parameters for this polymerase and associated buffers. Table 16 lists the parameters of the iTaq protocol.

Table 16. iTaq protocol

iTAQ-FST		
For Fast PCR		
Step	Target Temperature (°C) or GOTO Step	Time (min:sec) or Repeats
1	98	0:30
2	92	0:01

Table 16. iTaq protocol (continued)

3	70	0:10
4	GOTO 2	29x
5	72	0:30
6	END	

Optimized Protocols Using iProof Polymerase

iProof DNA polymerase is a high-fidelity polymerase that is designed to quickly and precisely amplify long targets using a proofreading enzyme combined with a DNA binding protein. Three protocols optimized using the iProof DNA polymerase are preinstalled on the C1000 thermal cycler. These protocols include optimal parameters for the iProof enzyme and associated buffers, including an initial 95°C step to activate the enzyme and a final long extension step. Each of these protocols is adjusted for a distinct range of target sizes. Table 17 lists the parameters in each protocol

Table 17. iProof protocol

	IPRF1KB		IPRF8KB		IPRF15KB	
	For Fast Amplification of Targets Less Than or Equal to 1 kb Targets		To Amplify Targets Less Than or Equal to 8 kb		To Amplify Targets Less Than or Equal to 15 kb	
Step	Target Temperature (°C) or GOTO Step	Time (min:sec) or Repeats	Target Temperature (°C) or GOTO Step	Time (min:sec) or Repeats	Target Temperature (°C) or GOTO Step	Time (min:sec) or Repeats
1	98	0:30	98	0:30	98	0:30
2	98	0:05	98	0:05	98	0:05
3	60	0:10	60	0:10	60	0:10
4	72	0:30	72	4:00	72	7:30
5	GOTO 2	29x	GOTO 2	29x	GOTO 2	29x
6	72	5:00	72	5:00	72	5:00
7	12	Infinite hold ∞	12	Infinite hold ∞	12	Infinite hold ∞
8	END		END		END	

Optimized Protocol Using the iScript Reverse Transcriptase

Reverse transcription protocols are used to amplify DNA from an RNA template. Table 18 lists the parameters of the protocol optimized using the iScript reverse transcriptase.

Table 18. iScript protocol

Step	ISCRIP T	
	To Amplify DNA from an RNA Template	
Step	Target Temperature (°C) or GOTO Step	Time (min:sec) or Repeats
1	25	0:30
2	42	30:00
3	85	5:00
4	12	Infinite hold ∞
5	END	

Nested Primer Protocols

Nested primers amplify a specific DNA sequence from a large, complex DNA template such as genomic DNA. Table 19 lists the parameters in each protocol.

Table 19. Nested primer protocol

Step	NESTPR2		NESTPR3	
	Two-Step Protocol Using Nested Primers		Three-Step Protocol Using Nested Primers	
Step	Target Temperature (°C) or GOTO Step	Time (min:sec) or Repeats	Target Temperature (°C) or GOTO Step	Time (min:sec) or Repeats
1	95	4:00	95	0:30
2	95	0:30	95	0:30
3	65	0:30	55	0:30
4	GOTO 2	39x	72	0:30
5	72	7:00	GOTO 2	39x
6	12	Infinite hold ∞	72	7:00
7	95	0:30	12	Infinite hold ∞
8	65	0:30	95	0:30
9	GOTO 7	39x	55	0:30
10	72	7:00	72	0:30
11	12	Infinite hold ∞	GOTO 8	39x

Table 19. Nested primer protocol (continued)

12	END		72	7:00
13			12	Infinite hold ∞
14			END	

Appendix B: References

1. Breslauer KJ, et al., Predicting DNA duplex stability from the base sequence, *Proc Nat Acad Sci* 83, 3746–50 (1986)
2. Sugimoto N, et al., Improved thermodynamic parameters and helix initiation factor to predict stability of DNA duplexes, *Nucleic Acids Res* 24, 4501–4505 (1996)

Appendix C: Ordering Information

Components of Bio-Rad's 1000-Series Thermal Cyclers

Table 20 lists the components of the 1000-series instruments and software. Catalog numbers are included for easy ordering.

Table 20. Catalog numbers for the 1000-series instruments and software

Catalog Number	Description
Thermal Cycler Bases and Reaction Modules	
184-1000	C1000 thermal cycler base
184-2000	S1000 thermal cycler base
184-0096	96-well fast reaction module
184-0048	Dual 48/48 fast reaction module
184-0384	384-well reaction module
185-1096	C1000 thermal cycler with 96-well fast reaction module
185-1048	C1000 thermal cycler with dual 48/48 fast reaction module
185-1384	C1000 thermal cycler with 384-well reaction module
185-2096	S1000 thermal cycler with 96-well fast reaction module
185-2048	S1000 thermal cycler with dual 48/48 fast reaction module
185-2384	S1000 thermal cycler with 384-well reaction module
Real-Time Detection Modules	
184-5096	CFX96 optical reaction module
184-5385	CFX384 optical reaction module
Software	
184-4000	C1000 Manager software
184-5000	CFX Manager software

Table 20. Catalog numbers for the 1000-series instruments and software (continued)

Catalog Number	Description
184-5001	CFX Manager software, security edition, 1 user license
184-5005	CFX Manager software, security edition, 5 user licenses
184-5010	CFX Manager software, security edition, 10 user licenses

Accessories for the 1000-Series Thermal Cyclers

Table 21 lists accessory parts for the 1000-series instruments, including product descriptions and catalog numbers.

Table 21. Catalog numbers of accessories for the 1000-series thermal cyclers

Catalog Number	Description
184-8000	Shielded USB cable
184-9000	Tube frame for providing structural support for one or a few tubes
184-1001	1000-series connectivity kit, includes optical mouse, mouse pad, and USB key

Index

A

- adding
 - beep, 28
 - extended time, 27
 - temperature gradient, 24
 - temperature increment, 26
 - users, 78
- Administrator Settings menu, 85
- advanced functions, 81
- air flow
 - testing for, 91
- air vents, 1
- alphanumeric keys, 3
- attached folders, 12

B

- beep, 21, 28
- Bio-Rad Laboratories
 - contact information, iii
 - resources, iii
 - technical support, iii
 - web site, iii
- BioRadiations Magazine volume 118, 63
- Breslauer, 47, 48, 103
 - interaction constants, 48

C

- C1000 Manager software, 86
 - adding users, 78
 - assigning rights for user roles, 79
 - benefits, 69
 - computer requirements, 69

- controlling thermal cyclers, 69, 71
- copying a protocol from a USB key, 75
- creating a protocol, 72
- editing a protocol, 73
- Email Preferences tab, 76
- File Preferences tab, 77
- installing the drivers for Windows XP, 70
- managing user access, 78
- monitoring a run, 74
- Protocol Preferences tab, 78
- removing users, 78, 79
- running a protocol, 73
- running a protocol from a USB key, 75
- viewing connected thermal cyclers, 72
- C1000 thermal cycler
 - air flow, 91
 - connecting to S1000 cyclers, 87
 - controlling S1000 cyclers, 81, 86
 - insufficient air flow, 91
 - logging in, 82
 - logging off, 83
 - main screen, 2
 - operating S1000 cyclers, 87
 - plugging in, 6
 - protocol parameters, 20
 - renaming instrument, 12
 - self-test, 7
 - transferring protocols, 66
 - turning on, 6
 - warranty, iii
- canceling a protocol run, 41
- catalog number
 - 1000-series thermal cyclers, 105
 - accessories, 106
 - C1000 Manager software, 105
 - C1000 thermal cycler, 105

- CFX Manager software, 105
- reaction modules, 105
- real-time detection modules, 105
- S1000 thermal cycler, 105
- tube frame, 106
- USB cable, 106
- command keys, 3
- control panel, 1, 86
 - keys, 3
 - liquid crystal display (LCD), 2
 - self-test screen, 2
- cooling fins, 5
- copying
 - all files from a folder, 56
 - folder, 57
 - protocol, 60
- creating a new folder, 55
- creating a protocol, 19
 - C1000 Manager software, 72
 - Protocol AutoWriter software, 48
 - when Ta is not known, 51

D

- data ports, 81, 86
- deleting
 - folder, 58
 - protocol, 61

E

- editing a protocol, 19, 22
 - adding a beep, 28
 - adding an extend time, 27
 - C1000 Manager software, 73
 - in a GOTO step, 29
 - removing a beep, 29
 - removing a ramp rate, 27
 - removing a temperature gradient, 26
 - removing an extend time, 28
- email notification set up
 - in software mode, 76
 - in stand-alone operation mode, 1, 14
- Email Preferences tab
 - C1000 Manager software, 76
- error messages, 92, 93
 - run logs, 94
- extend
 - hold time, 21, 27
 - removing time, 28

F

- faster PCR
 - optimizing a protocol, 63
- file library
 - attached folders, 12
 - MAIN folder, 10
 - opening files, 10
 - PREVIOUS RUNS folder, 10
 - protocol folder, 10
 - SYSTEM folder, 11
 - USERS folder, 11
- File Preferences tab, 77
- folder
 - copying all files, 56
 - copying or moving, 57
 - creating new, 55
 - deleting, 58
 - renaming, 59
- function keys, 3
- fuses, 92

G

- Gene Expression Gateway, 63, 66
- GOTO step
 - changing parameters in, 29
- gradient
 - adding, 24
 - calculator, 84
 - definition, 21
 - range, 21
 - removing, 26
 - temperature, 53

H

- hold time, 53
 - changing, 22

I

- increment
 - adding, 26
 - definition, 21
- incubating samples, 43
 - ending the incubation, 44
- installing
 - C1000 Manager software, 70
 - drivers for Windows XP, 70
- instrument tree, 87

K

keys

- alphanumeric, 3
- command, 3
- function, 3
- navigation, 3
- Protocol AutoWriter, 3

L

- lid lever, 5
- lid temperature
 - modifying, 31
 - role in PCR outcome, 31
- logging in, 82
- logging off, 83

M

- MAIN folder, 10, 81
- MAIN screen, 87
- main screen, 2
- maintenance
 - reaction modules, 90
- managing protocol files, 54
- managing protocol folders, 54
- moving
 - folder, 57
 - protocol, 60

N

- navigation keys, 3

O

- optimizing a protocol
 - annealing temperature steps, 65
 - for faster PCR, 63

P

- pausing a run, 39
- PCR protocol steps, 53
- plastic consumables for PCR, 67
- preinstalled protocols
 - for iProof DNA polymerase, 99
 - standard protocol, 97

- touchdown protocol, 98
 - using iTaq polymerase, 98
 - using the iScript polymerase, 100
- PREVIOUS RUNS folder, 10
- protocol
 - copying or moving, 60
 - deleting, 61
 - folder, 10
 - for iProof polymerase, 99
 - for iScript reverse transcriptase, 100
 - for iTaq DNA polymerase, 98
 - managing files, 54
 - managing folders, 54
 - monitoring a run, 38
 - naming, 33
 - nested primer protocols, 100
 - optimizing annealing temperature, 65
 - optimizing for faster PCR, 63
 - optimizing PCR with small samples, 66
 - pausing a run, 39
 - preinstalled standard protocols, 97
 - preinstalled touchdown protocol, 98
 - renaming, 61
 - running multiple blocks, 36
 - saving, 33
 - skipping steps, 40
 - standard protocols, 97
 - steps for PCR, 53
 - transferring from another cycler, 66
 - troubleshooting options, 66
- Protocol AutoWriter key, 3
- Protocol AutoWriter software
 - creating a protocol, 48, 51
 - overview, 45
 - protocol speed settings, 45
 - reducing overall run time, 46
 - steps in a protocol, 45
 - Ta calculator, 46
 - when the Ta is unknown, 51
- Protocol Preferences tab, 78

R

- ramp rate, 21
 - changing, 27
 - definition, 21
 - removing, 27
- reaction block
 - loading samples into, 9
 - reaction vessels, 5
- reaction module bay, 1
- reaction modules
 - catalog numbers, 105

- cleaning, 90
- cooling fins, 4, 5
- lid, 5
- lid force knob, 5
- lid lever, 5
- loading sample vessels, 9
- loading samples, 9
- maintenance, 90
- number of blocks, 4
- reaction block, 5
- recommended sample volumes, 4
- sample block, 5
- specifications, 4
- status LED, 5
- reaction vessels, 67
- references, 103
- removing
 - temperature gradient, 24
 - temperature increment, 26
 - users, 78
- renaming
 - folder, 59
 - protocol, 61
 - thermal cycler, 12
- replacing fuses, 92
- resuming a run, 40
- roles
 - administrator, 79
 - guest, 79
 - operator, 79
 - principal, 79
- run
 - canceling, 41
 - methods, 35
 - monitoring, 38, 74
 - multiple blocks, 36
 - pausing, 39
 - protocol from a USB key, 75
 - resuming a protocol, 39
 - using C1000 Manager software, 73
- run logs, 11, 94
- running
 - protocol, 35

S

- S1000 thermal cycler
 - connecting to C1000 cycler, 87
 - operating with a C1000 cycler, 87
- safety
 - compliance, v
 - warning labels, iv
- sample volume

- changing, 32
 - role in PCR outcome, 31
 - small amount, 66
- saving
 - protocol, 33
- sealing options, 67
 - wax seal, 66
- self-test screen, 2
- service testing, 2
- skipping steps in a protocol, 40
- specifications
 - for safe use, v
 - reaction modules, 4
 - regulatory compliance, v
- Sugimoto, 47, 103
- SYSTEM folder, 11
 - functions, 86

T

- Ta calculator
 - overview, 46
- technical support
 - contact information, iii
- temperature
 - changing hold time, 22
 - changing lid temperature, 32
 - changing parameter, 22
 - hold time, 20
 - step, 20
- temperature control modes
 - block mode, 31
 - calculated mode, 31
- temperature hold, 53
- test port, 2, 86
- timer
 - protocol count-down, 75
- transferring protocols, 66
- troubleshooting
 - error messages, 92
 - low yield of target PCR product, 67
 - nonspecific PCR products, 67
- troubleshooting options, 66

U

- USB A port, 1, 2, 86
- USB B port, 2, 86
- USB key
 - copying protocols from, 75
 - running protocols from, 75
- users

- adding to the C1000 thermal cycler, 78
- USERS folder, 11, 81
- Utilities Menu
 - functions, 83

V

- virtual key pad, 13

W

- warning
 - error messages, 93
 - labels, iv
 - labels on instrument, v
 - messages, 93
 - troubleshooting, 92
- warning messages, 93
- warranty, iii
- wax seal, 66
- web site, iii, 63, 66
- writing conventions in the manual, iii



**Bio-Rad
Laboratories, Inc.**

Life Science
Group

Web site www.bio-rad.com **USA** 800 4BIORAD **Australia** 61 02 9914 2800 **Austria** 01 877 89 01 **Belgium** 09 385 55 11 **Brazil** 55 21 3237 9400
Canada 905 364 3435 **China** 86 21 6426 0808 **Czech Republic** 420 241 430 532 **Denmark** 44 52 10 00 **Finland** 09 804 22 00 **France** 01 47 95 69 65
Germany 089 318 84 0 **Greece** 30 210 777 4396 **Hong Kong** 852 2789 3300 **Hungary** 36 1 455 8800 **India** 91 124 4029300 **Israel** 03 963 6050
Italy 39 02 216091 **Japan** 03 6361 7000 **Korea** 82 2 3473 4460 **Mexico** 52 555 488 7670 **The Netherlands** 0318 540666 **New Zealand** 0508 805 500
Norway 23 38 41 30 **Poland** 48 22 331 99 99 **Portugal** 351 21 472 7700 **Russia** 7 495 721 14 04 **Singapore** 65 6415 3188 **South Africa** 27 861 246 723
Spain 34 91 590 5200 **Sweden** 08 555 12700 **Switzerland** 061 717 95 55 **Taiwan** 886 2 2578 7189 **United Kingdom** 020 8328 2000
