

## Chapter 3

# 3

# Installation

## Jumper

<b>Jumper</b>		<b>Refer to page</b>
◆ JP4	- Real time Clock RTC clean	11
◆ FAN1	- FAN CONN. for Socket 370 CPU	19
◆ FAN2	- FAN CONN. for AGP	19
◆ FAN3	- FAN CONN. for System	19
◆ JP5	- LAN Card Wake Up	24
◆ JP7	- CPU Front Side Bus Setting Jumper	25
◆ JP5	- CPU Ratio Setting Jumper	25

## Expansion Slot

## Which page

♦ 168 pin DIMM Socket	13
♦ CPU Socket370	15
♦ AGP (Accelerator Graphic port) SLOT	17
♦ PCI SLOT 1,2,3 -32bits PCI SLOT	17
♦ ISA SLOT1,2 - 16bits ISA SLOT	17

## Connectors

## Refer to page

♦ PS2/Mouse- PS/2 Mouse port.	18
♦ KB1 - AT Keyboard port	18
♦ USB - USB Port	18
♦ COM1 - COM 1 serial port	18
♦ PRINT - Parallel port	18
♦ COM2 - COM 2 serial port	18
♦ FDC - FLOPPY connector	18
♦ IDE1 - Primary IDE connector	20
♦ IDE2 - Secondary IDE connector	20
♦ IR - IrDA connector	21
♦ JP6 - HDD LED	22
♦ JP6 - Reset Switch	22
♦ JP6 - Speaker Connector	23
♦ JP6 - Power LED	23
♦ JP6 - ATX Power switch	23
♦ PW1/PW2 - ATX/AT Power Connector	23

## System Installation Setup

---

Before using your computer, you must finish the following steps:

1. Set jumpers on mainboard.
2. Install SDRAM module.
3. Install the Socket 370 CPU Processor.
4. Connect Ribbon Cables, Cabinet Wires, and Power supply.
5. Install Add on Cards.
6. Setup the BIOS software.

## Static Electricity Precaution

---





- ⌚ Keep the mainboard and other system components in their anti-static packaging until you are ready to install them.
- ⌚ Do all preparative work on a static-free surface with the main board components facing up.
- ⌚ Unplug your computer when working on the inside.
- ⌚ Wear an Anti-static wrist strap.
- ⌚ Hold the system components, boards or cards by its edges only. Be careful not to touch any of IC chips, circuitry, contacts or connections, especially gold contacts on the mainboard.

# Jumper Settings

---

## Jumpers

Several hardware settings are made through the use of jumper caps to connect jumper pins (Jxx) on the mainboard. See "Map of the mainboard" to locate the jumpers.

The jumper settings will be described numerically such as [----], [1-2], [2-3] for no connection, connect pins 1 & 2, and connect pins 2 & 3 respectively. Pin 1 for our mainboard is always on top one or on the left when holding the mainboard with the keyboard away from yourself. "P1" is written besides pin 1 on jumper with three pins. The jumpers will also be shown graphically such as  to connect pin 1 & 2 and  to connect 2 & 3. Jumpers with two pins will be shown as  for Short (on) and  for Open (off). For manufacturing simplicity it may be sharing pins from other groups. Use the diagrams in this manual instead of following the pin layout on the board. Settings with two jumper numbers require that both jumpers be moved together. To connect the pin, simply place a plastic jumper cap over the two pins as diagrammed.

## Real Time Clock (RTC) RAM - JP4 :

The CMOS RAM is powered by the onboard button cell battery. To clear the RTC data:

(1) Turn off your AC Power, (2) Move this jumper to "3-4Pin Clear Data", (3) Move the jumper back to "Default", (4) Turn on your computer, (5) Hold down <Delete> during bootup and enter BIOS setup to re-enter user Preferences.

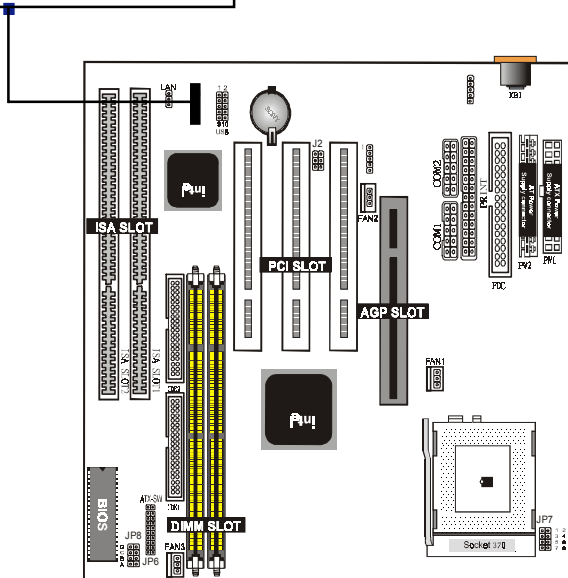
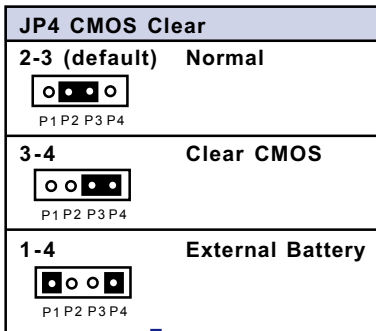

## System Memory ( DIMM Module)

---

This **6BX85/6ZX85/6VIA85/6VIA85P** mainboard supports, two 168 pins DIMM ( Dual Inline Memory Module) of 16 MB, 32 MB, 64 MB, 128 MB ,256MB to form a memory size between 16MB to 256MB.

The DRAM can be either 45ns,50ns,or 60ns 3.3v SDRAM,and 3.3v Enhanced Data Output (EDO) RAM.

Install memory in any or all Banks in Combination:

Bank	Memory module
DIMM 1	16MB,32MB,64MB,128MB,256MB
( Bank 0-1 )	168 pin,3.3v SDRAM / EDO RAM
DIMM 2	16MB,32MB,64MB,128MB,256MB
( Bank 2-3 )	168 pin 3.3v,SDRAM / EDO RAM
	<b>Total System Memory(Max 512MB)</b>

### Note :

- ◆ The DIMM Slot does not support any 5v EDO DIMM module.
- ◆ The DIMM Slot does not support any 5v SDRAM DIMM module.
- ◆ Memory speed setup is required through "Auto Configuration" in BIOS chipset Setup of BIOS SOFTWARE. If several speed memories are used, You must set Auto Configuration to low. Example If both 50ns, 60ns are used, Please set Auto configuration to 60ns.
- ◆ It's allowed any DIMM module put in any DIMM slot. It's allowed there are different capacity DIMM module in all DIMM slot.

# DIMM Memory Installation

Insert the module (s) as shown. Because the number pins are different on either side of the breaks, the module will only fit in the orientation as shown. SDRAM DIMM modules have different pin contact on each side and therefore have a higher pin density.

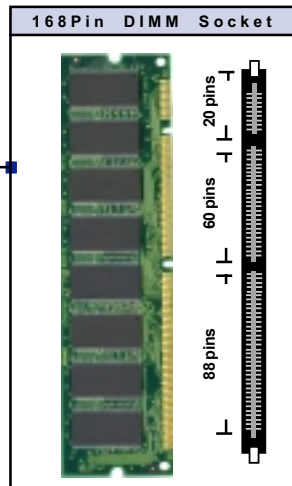
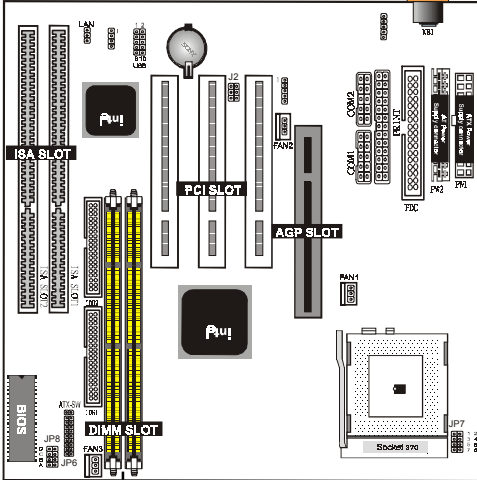

The Dual Inline Memory Module (DIMM) memory module must be 3.3v Extended Data Output (EDO) DRAM or SDRAM. You can identify the type of DIMM module by the illustration below:

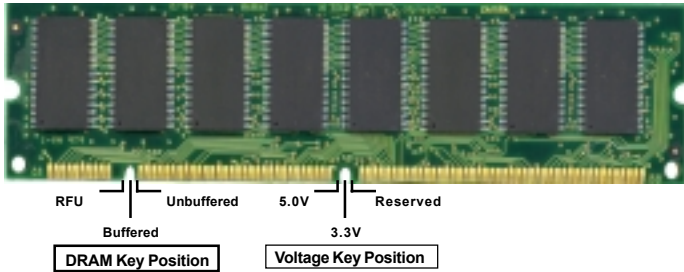

### 168 Pin DRAM DIMM Notch Key Definitions

The notch on the DIMM module will shift between left, center, or right to identify the type and also to prevent the wrong type to be inserted into the DIMM slot on the Mainboard. You must ask your retailer for Specifications before purchasing.

**Four clock signals are supported on this mainboard**



# CPU Installation

The motherboard provides a ZIF socket 370. The CPU that came with the motherboard should have a fan attached to it to prevent overheating . If this is not the case then purchase a fan before you turn on your system.

To install a CPU , first turn off your system and remove its cover. Locate the ZIF socket and open it by first pulling the lever sideways away from the socket then upwards to a 90-degree right angle. Insert the CPU with the correct orientation shown . The notched corner should point towards end of the lever. Because the CPU has a corner pin for two of the four corners, the CPU will only fit in the orientation as shown.

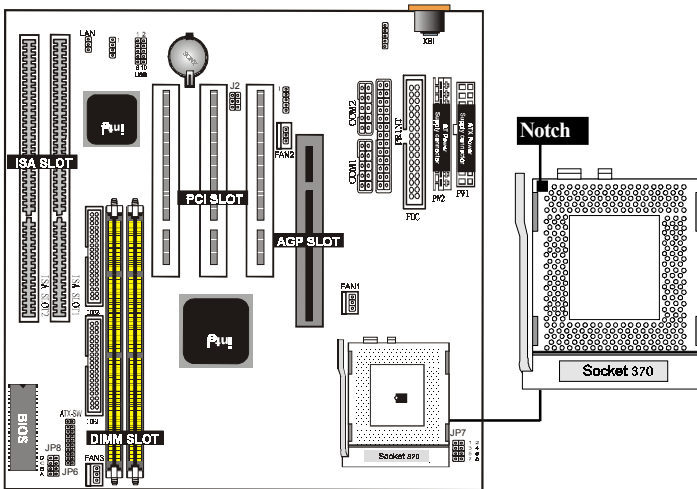

## **Clearance Requirements**

---

To maintain proper airflow once the processor is installed on the mainboard, the processor and fan heatsink require certain space clearances. The clearance above the processor must be at least 0.3 inch. The clearance on at least 3 of 4 sides of the processor and fan heatsink must be at least 0.2 inch. All cables (for Floppy drive, Hard drive, CD-ROM, and so on) must be routed clear of the processor and its airspace.

## **Fan Exhaust**

---

The processor must be kept cool by using a processor with heatsink and fan attached. The temperature of the air filled with the fan/heatsink cannot exceed 45 °C (113 °F). The ambient or room temperature must be below 37 °C (99 °F).

# EXTERNAL CONNECTORS

Both Ribbon cable and Connectors on board are with direction signs to avoid that user insert wrong direction. On other hand, the ribbon cables should always be connected with the red stripe on the pin 1 of side of the connector.

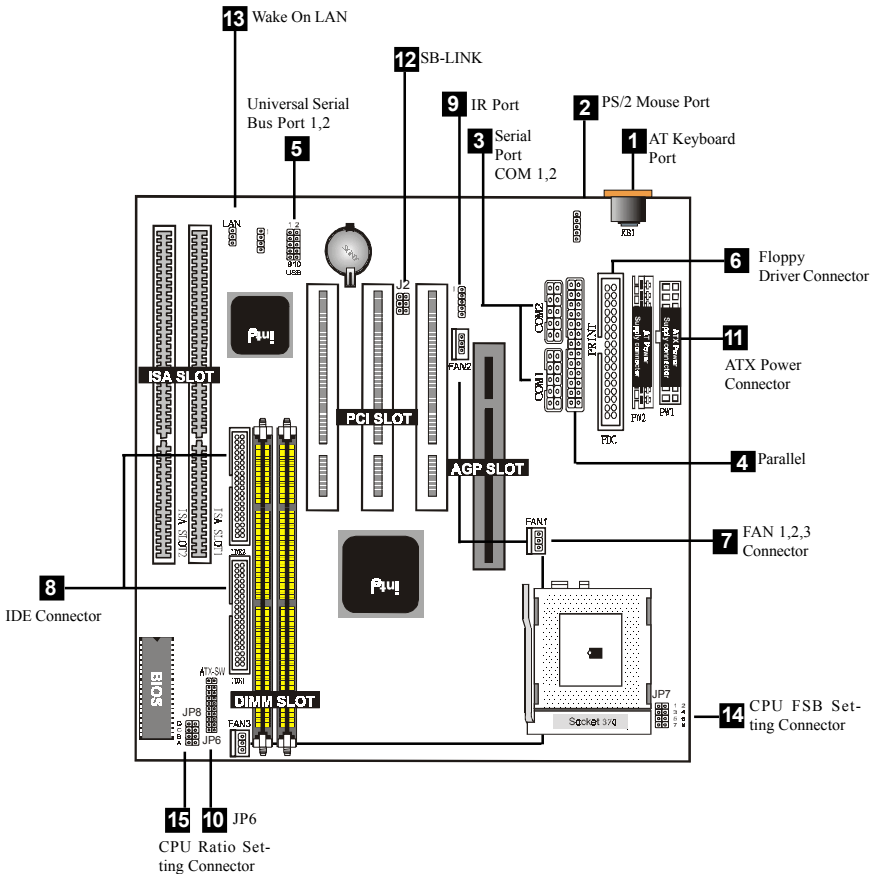

**1. AT Keyboard port**

This connector will compatible with standard at AT size (large DIN) keyboard plugs. You may use a DIN to mini DIN adapter on standard AT keyboards.

**2. PS/2 Mouse port**

This system will direct IRQ12 to PS/2 mouse.

**3. Serial Port COM 1 and COM 2 port**

The two serial ports can be used for pointing devices or other serial devices. See "Onboard Serial Port" in chipset Feature Setup of the BIOS SOFTWARE.

**NOTE:**

**Serial {D-type 25pin (F) } must be connected to the serial port.**

**4. Parallel Printer port**

You can enable the parallel port and choose the IRQ through " Onboard Parallel Port" in Chipset. Feature Setup of the BIOS SOFTWARE.

**5. Universal Serial BUS Ports 1 & 2**

Two USB ports are available for connecting USB devices.

**6. Floppy drive connector**

This connector supports the provided floppy drive ribbon cable. After connecting the single end to the board, connect the two plus on the other end to the floppy drives.

## 7. FAN1 , FAN2 , FAN3 CPU Cooling Fan (FAN/PWR)

These connectors support cooling fans of 500mAmp (6Watt) or less. Orientate the fans so that the heatsink fins allow airflow to go across the onboard heat sink(s) instead of the expansion slots. Depending on the fan manufacturer, the wiring and plug may be different. The red wire should be positive, while the black should be ground. Connect the fan's plug to the board taking into consideration the polarity of this connector.

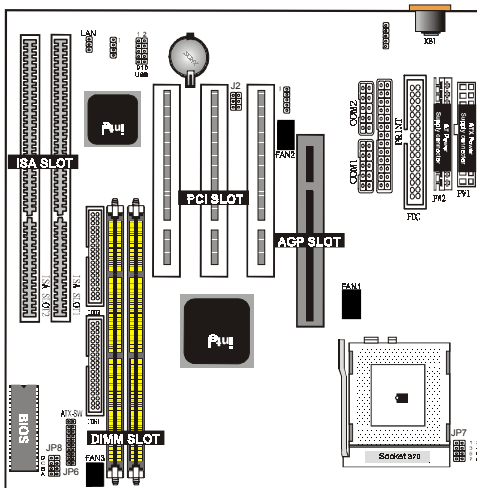

### FAN1/2 CPU Cooling FAN

Pin	Description
P1	Ground
P2	+12VDC
P3	Signal

### FAN3 CPU Cooling FAN

Pin	Description
P1	Ground
P2	+12VDC
P3	Ground

#### NOTE :

The "Rotation" signal is to be used only by a specially designed fan with rotation signal.

#### WARNING :

The CPU and/or motherboard will overheat if there is no air flowing across the CPU and onboard heatsinks. Damage may occur to the motherboard and/or the CPU fan if these pins are incorrectly used. These are not jumpers, do not place jumper caps over these pins.

8. **Primary / Secondary IDE connectors (Two 40-pin Blocks)**

These connectors support the provided IDE hard disk ribbon cable. After connecting the single end to the board, connect the two plugs at the other end to your hard disk no space(s) . If you install two hard disks, you must configure the second drive to Slave mode by setting its jumper settings. BIOS now supports SCSI device or IDE CD-ROM boot up (see "HDD Sequence SCSI/IDE First" & "Boot Sequence" in the BIOS Features Setup of the BIOS SOFTWARE) (Pin 20 is removed to prevent inserting in the wrong orientation when using ribbon cables with pin 20 plugged).

**Tip :**

**You may configure two hard disks to be both Masters using one ribbon cable on the primary IDE connector. You may install one operating system on an IDE drive and another on a SCSI drive and select the right one through BIOS Feature Setup.**

## 9. IrDA / Fast IR-Compliant infrared module connector (J1)

This connector supports the optional wireless transmitting and receiving infrared module. This module mounts to a small opening on system cases that support this feature. You must also configure the setting through “UART2 Use Infrared” in Chipset Feature Setup to select whether UART2 is directed for use with COM2 or IrDA. Use the five pins as shown on the Back View and connect a ribbon cable from the module to the motherboard according to the pin definitions.

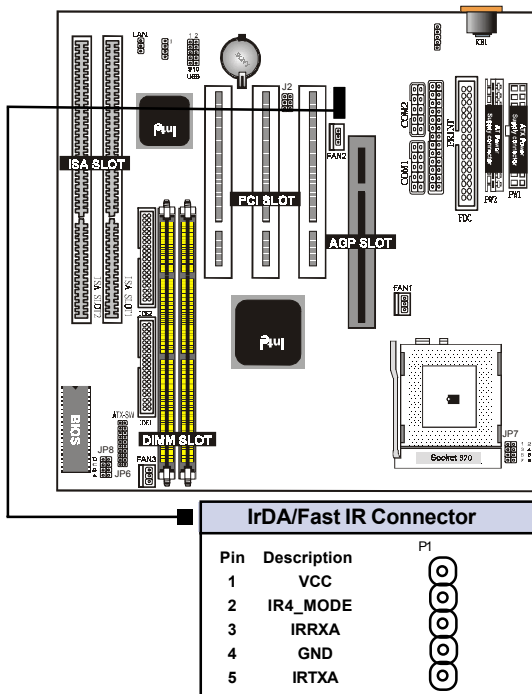

## 10. JP6

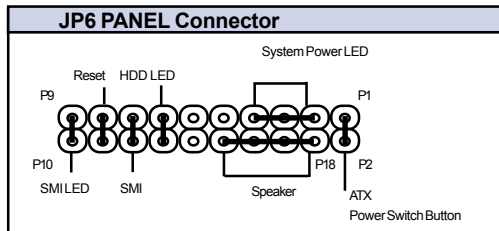

### a. IDE activity LED (HD\_LED)

This connector supplies power to the cabinet's IDE activity LED. Read and write activity by devices connected to the Primary or Secondary IDE connectors will cause the LED to light up.

### b. Power LED Lead (PW-LED)

The system power LED lights when the system's power is on.

### c. SMI Suspend Switch Lead (SMI)

This allows the user to manually place the system into a suspend mode or "Green" mode where systematic activity will be instantly decreased to save electricity and expand the life of certain components when the system is not in use. This 2-pin connector (see the figure below) connects to the case-mounted suspend switch. If you do not have a switch for the connector, you may use the "Turbo Switch" since it does not have a function. SMI is activated when it detects a short to open moment and therefore leaving it shorted will not cause any problems. It may require one or two pushes depending on the position of the switch. Wake-up can be controlled by settings in the BIOS but the keyboard will always allow wake-up (the SMI lead cannot wake-up the system). If you want to use this connector, "Suspend Switch" in the Power Management Setup of the BIOS SOFTWARE section should be on the default setting of Enable

### d. SMI Suspend LED

### e. Reset Switch Lead (RST)

This 2-pin connector connects to the case-mounted reset switch for rebooting your computer without having to turn off your power switch. This is a preferred method of rebooting in order to prolong the life of the system's power supply.



**f. Speaker Connector (SPEAKER)**

This 4-pin connector connects to the case-mounted speaker.

**g. ATX Power Switch (PW\_BN)**

The system power is controlled by a momentary switch connected to this lead. Pushing the button once will switch the system ON. The system power LED lights when the system's power is on .

**11. ATX Power Supply Connector (20-pin block) - PW1**

This connector connects to a ATX power supply. The plug from the power supply will only insert in one orientation because of the different hole sizes. Find the proper orientation and push down firmly making sure that the pins are aligned.

**IMPORTANT:**

**Make sure that the ATX power supply can take at least 10mAmp load on the 5Volt standby lead (5VSB). You may experience difficulty in powering on your system without this.**

**PW1**

Pin	Description	Pin	Description
1	3.3V	2	3.3V
3	GND	4	5V
5	GND	6	5V
7	GND	8	PW-OK
9	5VSB	10	12V
11	3.3V	12	-12V
13	GND	14	PS-ON
15	GND	16	GND
17	GND	18	-5V
19	5V	20	5V

## 12. SB-LINK : J2

“SB-Link” originated from Creative to propose a standard which can be a bridge between the mainboard and PCI sound card to deliver Sound Blaster 16 compatibility under DOS real-mode environment. Sound Blaster 16 was almost the standard of the ISA Bus sound cards, a lot of games were Programmed for Sound Blaster especially under DOS environment. If the users are still interested in playing these game titles, they might have compatibility problems with the new up graded PCI Bus sound card. This header adopts Intel’s PC/PCI technology to deliver Sound Blaster 16 compatibility to PCI Bus sound card, enabling users to play real-mode DOS games. Connect the cable provided by PCI sound card to this connector.

## 13. Wake Up On LAN : JP5

This connector connects LAN cards and a Wake On LAN output. When the system is in soft-off mode LAN activity will power on the system.

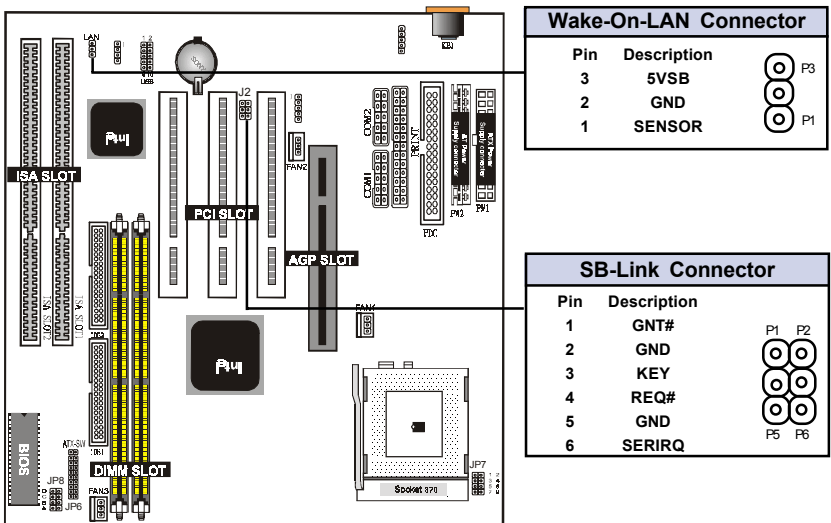

#### 14. CPU Type Selector jumper : JP7

CPU Type Select					
66 Mhz	1-2	3-4	5-6	7-8	Close
100 Mhz	1-2	3-4	7-8		Close
133 Mhz	1-2	3-4			Close

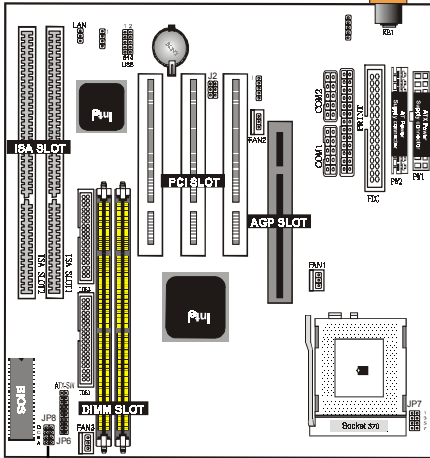

#### 15. CPU Ratio Selector jumper :

	A	B	C	D
2.0X	ON	ON	ON	ON
2.5X	OFF	ON	ON	ON
3.0X	ON	OFF	ON	ON
3.5X	OFF	OFF	ON	ON
4.0X	ON	ON	OFF	ON
4.5X	OFF	ON	OFF	ON
5.0X	ON	OFF	OFF	ON
5.5X	OFF	OFF	OFF	ON
6.0X	ON	ON	ON	OFF
6.5X	OFF	ON	ON	OFF
7.0X	ON	OFF	ON	OFF
7.5X	OFF	OFF	ON	OFF
8.0X	ON	ON	OFF	OFF

Note : **ON : Close OFF : Open**

Date :    /    /

## Guarantee Sheet/Technical Fault Report

M/B Model No.: \_\_\_\_\_ Vender

Serial No. : \_\_\_\_\_

Date of Purchasing: \_\_\_\_\_

Hardware Configuration Used :

CPU	
RAM	
Video Card	
Hard Drive	
Other Card	

Diagnostic Software Used :

--

Fault Description :

--

Technical Support :

WWW : [www.acorp.com.tw](http://www.acorp.com.tw)

FAE : [fae@acorp.com.tw](mailto:fae@acorp.com.tw)